

62
June
1988

ISSN 0970-3993

elektor **INDIA**

157
Rs. 8.00

electronics

THE PRACTICAL MAGAZINE WITH THE PROFESSIONAL APPROACH

PLOTTER

Artificial intelligence
Morse trainer
Canometer

Swade shif

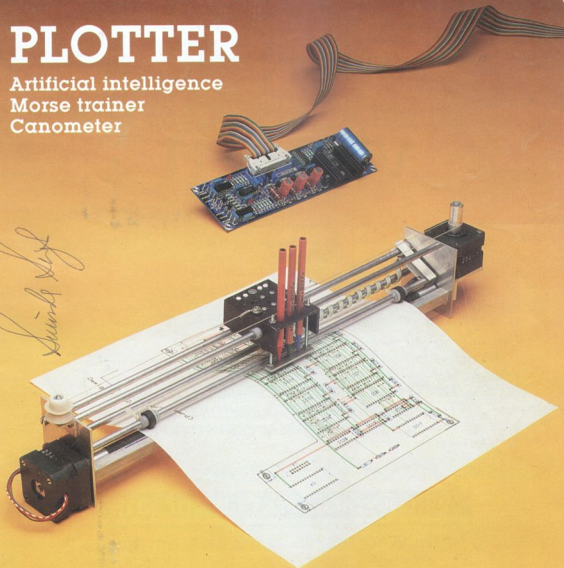

Publisher: C.R. Chandarana
Editor: Surendra Iyer
Technical Editor: Ashok Dongre
Circulation: J. Dhas
Advertising: B.M. Mehta
Production: C.N. Mithagari

Address:
 ELEKTOR ELECTRONICS PVT. LTD.
 52, C Proctor Road, Bombay-400 007 INDIA
 Telex: (011) 76661 ELEK IN

Overseas editions:

Elektor Electronics
 1, Harlequin Avenue,
 Great West Road, Brentford TW8, SEW U.K.
 Editor: Len Seymour

Pulitron Publicacoes Tecnicas Ltda
 Av Ipiranga 1160, 9º andar CEP 01440 Sao Paulo - Brazil
 Editor: Juliano Barsali

Elektor seri
 Route Nationale, Le Saux, B.P. 53
 592270 Baillet - France
 Editors: D R S Meyer;
 G C Readersdorf

Elektor Verlag GmbH
 Susterfeld-Strasse 25 100 Aachen - West Germany
 Editor: E J A Krempelsauer

Elektor EPE
 Karaiskaki 14 16673 Voula - Athens - Greece
 Editor: E Xanthoulis

Elektuur B.V.
 Peter Treckpoelstraat 2.4
 6191 VK Beek - the Netherlands
 Editor: P E L Kersemakers

Ferraria & Bento Lda
 R.D. Estefania, 32.1º 1000 Lisboa - Portugal
 Editor: Jorge Goncalves

Ingelek S.A.
 Plaza Republica Ecuador 2.28016 Madrid-Spain
 Editor: A M Ferrer

In Part:
 Kachorn Holdings PTY Ltd Cnr Fox Valley Road &
 Kiggle Street Wahroonga NSW 2076 - Australia
 Editor: Roger Harrison

Electronic Press AB
 Box 63
 182 11 Danderyd - Sweden
 Editor: Bill Cedrum

The Circuits are for domestic use only. The submission of designs of articles of Elektor India implies permission to the publisher to alter and translate the text and design and to use the contents in other Elektor publications and activities. The publishers cannot guarantee to return any material submitted to them. All drawings, photographs, printed circuit boards and articles published in Elektor India are copyright and may not be reproduced or imitated in whole or part without prior written permission of the publishers.

Patent protection may exist in respect of circuits, devices, components etc. described in this magazine.

The publishers do not accept responsibility for failing to identify such patent or other protection.



MEMBER

Printed at : Trupti Offset
 Bombay - 400 013
 Ph. 4923261, 4921354
 Copyright © 1988 Elektuur B.V.



Surendra Iyer

Volume-6 Number-6
 June-1988

Editorial

Be aware of data communication 6.05

Audio & Hi-Fi

PROJECT: Balanced line driver and receiver 6.19

Components

Copper on-ceramic microelectronic technology 6.22
 Breakthrough in superconducting materials 6.23
 Polarity indicator 6.51

Computers

PROJECT: Plotter-Part 1 6.40
 Artificial intelligence 6.48
 Simulating sight in robots 6.50

General interest

PROJECT: Morse trainer 6.30
 PROJECT: Computer controlled slide fader (2) 6.33
 Frequency doubler using 4011 6.37
 Making the weather work for you 6.52
 Liquid level indicator 6.54
 PROJECT: Canometer 6.55

Radio & Television

PROJECT: VLF convertor 6.26
 Signal processing and electronic encryption 6.28

Information

Telecommunication news 6.15
 Electronic news 6.16
 New products 6.62

Guide lines

Classified advertisements 6.74
 Index of advertisers 6.74

Selex-35

Switching transistor 6.58
 The transistor - an electronic potentiometer 6.59

Secret code phone

The Indian Telephone Industries Ltd., is developing a pilfer-proof public call office which may turn out to be the first of its kind in the world. The PCO prototype would be ready by October-November this year and it would consist of a dual tone multiple memory push button telephone which would be operated only through a subscriber code, according to Mr. U.D.N. Rao, chairman and managing director of the ITI.

The PCO would approximately cost Rs. 2000 as against Rs. 20,000 for the magnetic card or coin-operated phones. The secret code will be allotted to subscribers who deposit certain amount of money with the telephone department. Misuse of this PCO would be difficult as the secret code would be known only to the subscriber.

The ITI has also developed a low-cost satellite communication equipment for data transmission using technology called Spread Spectrum Multiplex Access. The equipment is being manufactured by the ITI Equatorial Satcom Ltd., a joint venture of the ITI and the US-based Equatorial Pacific International Company. The earth station for this system would cost about Rs. 400,000. Free of interference, the station would be able to receive facsimile data. Attempts are being made to add compressed voice channels to the station to enable voice transmission too.

During 1988-89, ITI would launch the production of 34 MBPS and 140 MBPS fibre optics equipment, a 2000-line electronic integrated local transit switch at a cost of Rs. 3000 per line, and a wide band digital microwave system of 140 MBPS with foreign collaboration. ITI would also clear the backlog of spares required for the department of telecommunications.

The ITI crossed the Rs. 500 crore production mark for the first time. In 1987-88, its production was estimated at Rs. 509.34 crores against Rs. 452.49 crores achieved in 1986-87. Profits before tax for 1987-88 have been estimated at Rs. 11.59 crores.

ITI's production during 1987-88 included 770,000 telephone lines and 260,000 lines of electronic switching equipment as against 752,000 telephones and 175,000 lines switching equipment made in the previous year. The value of

transmission equipment made in 87-88 was Rs. 107.68 crores compared to Rs. 999.28 crores in 86-87.

The company made a capital investment of about Rs. 75 crores last year. Production figures for various units of the ITI last year were: Bangalore Rs. 187.19 crores; Mankapur Rs. 118.69 crores; Ral Bareilly Rs. 81.59 crores; Naini Rs. 64.98 crores; Palghat Rs. 32.76 crores; Srinagar Rs. 8.22 crores.

Sathe's communication

Mr Vasant Sathe, Union minister for communication, is known for his unconventional utterances on matters of public importance. His forthright articles on the ills of Indian public sector have become legendary.

Jeagurating a digital electronic change in Bombay recently, Mr Sathe said that "self-reliance, indigenisation and appropriate technology are the equivalent of obsolescence in communication and information technology". Telephone companies should be on a par with international technological standards, he added.

The newly formed Mahanagar Telephone Nigam should take advantage of its autonomy and issue contracts to private parties for manufacture and maintenance. On behalf of the MTNL, Mr Sathe announced a Rs. 930 crore modernisation plan for the next three years. The plan includes doubling of Bombay's existing 5,000 public call points and conversion of the coin-operated phones to use credit cards. The MTNL should allow liberal participation of the private sector in fulfilling the target while the Nigam could concentrate on key areas like the import of technology, Mr Sathe said.

Mr. M.P. Shukla, managing director of MTNL said despite the 270,000 new lines commissioned in the last two years in Bombay, the waiting list had increased from 350,000 to 420,000 subscribers.

Switching labour

Rae Bareilly appears to be a strong contender for the third Electronic Switching Systems (ESS-III) unit. This is likely because over 6,500 workers at Rae Bareilly would become redundant with the phasing out of electromechanical switching systems by 1990 and a new unit alone can absorb the workforce.

To cope with the redundant labour, ITI proposes to begin production of electronic transmission equipment immediately at Rae Bareilly. The strategy would be to establish several new products vital to the telecommunication network in India so that no worker would be forced to remain idle.

The ITI chairman, Mr. Rao, dispelled any doubt over the siting of ESS-II by stating that this unit would be set up at Bangalore. Work was already in progress on the first 128 lines Rural automatic exchange at the model plant set up by the ITI and the C-DOT. The first production model would be stabilised within six months and transferred to Bangalore complex of the ITI. The 512-line port C-DOT switching system would then be made at the model plant and then transferred to the Bangalore plant in another 10 months, according to Mr. Rao. The ESS Max type would also be produced at the model plant first but commercial production would commence at another specially designed factory, adjacent to the existing model plant.

Regarding the slogan "An Rax A Day", scheduled to begin from April 1, 1988, Mr Rao pointed out that the ITI was already producing a RAX a day but the delay was in shifting and installing these exchanges. By the end of May 35 exchanges had been installed and progressively a higher rate would be achieved in later months.

Agreement with NEC

Bharat Electronics Ltd. and the ITI have signed a major technology transfer agreement with the NEC of Japan for indigenous production of Digital Microwave Transmission System. A steering committee comprising representatives of ITI, BEL, ECIL, department of electronics and telecommunications examined various offers and chose the offer of NEC.

Under the agreement, NEC will transfer know-how for the manufacture of 6 GHz, 140 megabits and 13 GHz, 34 megabits digital microwave system. The 6 GHz equipment will provide long haul trunk circuits while 13 GHz equipment will be used for connecting intra-city exchanges. The equipment will be manufactured by BEL and ITI using monolithic microwave integrated circuits, dielectric resonator devices, LSI and VLSI circuits and thick and thin film microcircuits.

TELECOMMUNICATION NEWS • TELECO

BEL and ITI will establish facilities to make 200 transceivers of 6 GHz and 100 transceivers of 13 GHz. Each company will make an investment of Rs. 10 crores. The transfer of technology charges will be shared equally. Manufacture from raw materials and components will start by the middle of 1990.

Data communication

A countrywide, regular public data network called "Vikram" will be commissioned in 1989. Since June, 1986 an experimental packet switching data net-

work has been in operation, linking Madras, Bombay and Delhi.

Mr. M.C. Venkatram, general manager, MTNL, Bombay, speaking at a seminar on data communications organised by the Victoria Jubilee Technical Institute, pointed out that MTNL was fully geared to providing all types of data communication facilities. Bombay can boast of possessing the largest number of data circuits anywhere in the country. Apart from 450 leased circuits, 33 dial up circuits and five public data network cir-

cuits, MTNL has provided 128 facsimile circuits on public switching telephone network. A large number of data circuits were provided to the railways, for their computerised reservation system, customs and the ONGC to name a few. Several banks, LIC, RBI and a number of private sector units are in the line for getting data circuits. Organisations like Air India, Indian Airlines and Citibank are among the users of dedicated data circuits. MTNL is also planning to provide videotext and electronic mail services.

ELECTRONICS NEWS • ELECTRONICS N

Russian Computers

India and the Soviet Union have signed a protocol on computers and electronics which envisages supply of Soviet supercomputers to India and setting up of joint ventures.

The Soviet Union has agreed to provide the required specifications of two super-computer models, Elbrus-3-I and EC-1068, before the end of July. India would examine the issue and depending on its response, the Soviet Union would make its commercial offer, according to Mr. K.P.P. Nambiar, secretary to the Department of Electronics, who signed the protocol on behalf of the government of India. An Indian delegation will visit the Soviet Union in November, 1988 to see the developments in computers and associated products.

At the end of the sixth session of the Indo-Soviet working group on computers and electronics, both the sides discussed the possibilities of production of full sets and systems for upgrading telephone lines in cities and villages. These systems were to be produced in India and delivered to the USSR. Also production of special telephone apparatus for mines, based on the Soviet know-how was considered. Cooperation in production of colour TV sets and other consumer electronic items in India and the USSR for supplying to third world countries figured in the joint session, attended by Mr. V.M. Neiman, deputy chairman of the state committee for computer techniques and informations of the USSR.

The Soviet Union has also shown interest in electron guns for colour picture tubes. A joint venture unit may be set up in India for producing the electron guns with the technical assistance of the USSR.

Hungary Follows

India and Hungary have signed an agreement for joint manufacture and marketing of electronic goods and components. Joint venture units to be set up in India would be mainly for producing television sets and TV picture tubes, according to Mr. Logis Koveskuti, president of the Council of Industrial Cooperatives, Hungary. In the next five years, Hungary would require at least 1.5 million TV picture tubes, it was stated.

Electronics constituted Rs. 10 crores in the total Indo-Hungarian trade turnover of Rs. 110 crores. The target is to increase the share of electronics to about Rs. 60 crores. At present, Hungary is supplying microwave equipment to Doordarshan and telecommunications equipment to Indian Railways and the Department of Telecommunications. India is also interested in Hungary's medical electronics.

Software tie-up

Under an emerging cooperation between India and Australia, India will be exporting computer software to Australia while Australian computer hardware firms will commence operations in India to develop software for

worldwide marketing.

A delegation of the Associated Chambers of Commerce and Industry which attended the India-Australia joint business council meeting at Melbourne recently gained this impression. The council took note of India's readiness to enter world markets in computer software through international collaboration. Australian computer software houses evinced keen interest in India's programme introducing computers in classrooms.

The joint business council, which was addressed by the Australian Prime Minister, also identified opportunities of business growth in diverse areas such as mining and mining equipment, telecommunication, food and manufactured food products, wood chips and pulp.

The consensus at the council meeting was that the double taxation agreement between the two countries should be speeded up; for Indian software industry to become a major partner in global software trade, the legal protection available in India should be clearly demonstrated; Cooperation would be vital in advanced computer software research projects; electronic components which are now imported by Australia from other Asian countries may be bought from India; and airlines should review freight costs and availability of space for high value, low weight cargo products.

'CRIS' goes abroad

Indian Railways, having laid the tracks

and built the carriages for a number of foreign countries, now extend their expertise in computerised reservation system to others.

Indonesia and Thailand have sought the help of the Centre for Railway Information Services (CRIS) in computerising passenger reservation services. CRIS will help in setting up facilities, along with the software package to be developed specifically for the two countries.

CRIS was set up two years ago to look after the entire computerisation programme of the railways. Encouraged by the queries from foreign clients, CRIS is evolving a marketing strategy for consultancy exports. Besides this, CRIS is now launching the phase II of the computerisation project which will bring smaller stations with light traffic on the computer map linking the four metropolitan cities. Already experiments had been carried out successfully by linking the terminals in small stations to the main computer in a metropolis. For example, Delhi and Amritsar were connected by a terminal and in the east, Dhanbad was connected to Calcutta. More terminals would be set up in stations not having dense traffic. Another aspect of the second phase is to link Madras, Bombay, Delhi and Calcutta for two-way communication so that return tickets can also be confirmed from these four cities. At present, only journey from the originating station is confirmed.

Liquor to Computer

United Breweries Limited is a well-known liquor company but this firm has diversified its operations into many areas. The latest is in computer printers. United Breweries will set up a joint venture with Genicom of US. The project will be set up in Bangalore.

Genicom is believed to be the largest manufacturer of computer printers in the world. Last year's turnover of Genicom was estimated to be \$325 million. Under the tie up, Genicom will buy back 20 to 25 per cent of the printers manufactured in India. Unitel Communications, a subsidiary of the United Breweries, had already entered into a technical collaboration with ATEA of Belgium for manufacturing EPABX systems. Chairman of the United Breweries, however, assures customers that the liquor units will not be closed down despite the diversifi-

cations. After all, liquor provides the bread and butter for the rest of the business!

RIBBONS TIE UP

Vinkas General Carbon Limited, New Delhi, has entered into a technical and financial tie up with General Company Limited, Osaka, Japan for making the EDP ribbons in India.

General Company has provided technical know-how to Olivetti, Italy and Texas Instruments, USA. Vinkas' project is located at Bhimtal in Nainital district of Uttar Pradesh. The unit will produce a wide range of nylon correctable and multistrike ribbons for use in most of the computer printers and electronic typewriters used in India. EDP ribbons are now imported. Vinkas will have exclusive export rights to West Asia and South Asia. The company will also explore the East European market.

OPTO Electronic Lab

A modern opto-electronic laboratory has been opened at the Machilipatnam unit of the Bharat Electronics Ltd. The sophisticated facilities being introduced will help BEL turn out precision optical lenses and prisms of international standards, 30 times faster. The facilities include high speed lapping, polishing, laser centering and edging, ultrasonic cleaning and multilayer thin film coating, besides testing and inspection of optical components and systems.

The opto-electronic unit inaugurated by Gen Harbans Lal, director-general of quality assurance in the ministry of defence, marks the first phase of modernisation initiated by BEL five years ago, after acquiring the Andhra Scientific Company. BEL has invested Rs. 5 crores so far and with a further investment of Rs. 6.50 crores in the next two years, Tanker Laser Sights and Infra red Searchlights will be added to the product profile of the Machilipatnam unit. By the end of the decade, the unit would have the capacity to produce optical and opto-electronic goods worth Rs. 50 crores.

Besides increasing the capacity, the modernisation will enable the manufacture of new types of high quality military opto-electronic products like passive night vision binoculars and goggles, weapon sights, Tank Laser Sights and TV camera zoom lenses. A dark tunnel of 60 meters has been constructed to

simulate field conditions of Star nights for measurements and calibration of night vision instruments. A computer-aided optical design facility is also being added. Most of the products, with the exception of Tank Laser Sights, are indigenously designed. Development and engineering work is being done in collaboration with the Instruments Research and Development Establishment, Dehradun.

Mobile Transmitters

BEL recently delivered to the All India Radio a 10 KW, medium wave mobile transmitting station and the first solid state frequency modulated (FM) broadcast transmitters, two units of 5 Kw and two units of 3 Kw each.

The mobile station, designed and developed by BEL, is a complete MW broadcast transmitting station cum studio on wheels. Portable taperecorders and audio mixers, radio networking terminal for receiving programmes from satellites and a rebroadcast are among the equipment provided. A trailer mounted diesel generator provides uninterrupted power supply. A transportable radiating mast which can be erected in a very short time and rest facilities for operators are among the other features. The OB van is also air-conditioned. Each mobile station costs about Rs. 75 lakhs of which the foreign exchange component is worth Rs. 3.80 lakhs.

The AIR placed orders for four such mobile stations in March, 1987. The first two were delivered in March 1988 as scheduled and the next two will be delivered by BEL in March, 1989.

The AIR had projected a requirement of 168 FM transmitters of 3 KW and 31 FM transmitters of 5 KW in the seventh plan. While the 3 KW transmitters would be supplied by BEL and GCEL in a proportion of 2 : 1, all the 31 5 KW transmitters would be supplied by BEL. The FEM transmitters will carry Hi Fi music without interference from other stations and noise.

GCEL Circuits

A thick film hybrid microcircuit laboratory was inaugurated by the DOE secretary, Mr K.P. Nambiar recently at the Gujarat Communications and Electronics Limited (GCEL).

The Laboratory has been set up at a cost of Rs. 45 lakhs of which the DOE provided about Rs 30 lakhs through the National Microelectronics Council. GCEL has completed work on 12 designs of hybrid microcircuits while 10 more circuits are in the pipeline.

Hybrid microcircuits have advantages like small size, less weight, high reliability, lower costs and higher capabilities. They have a variety of applications in communications, instrumentation, automobiles, television, audio and transmission equipment. These circuits can also be used for liquid crystal displays.

Racing Via Computers

A computerised betting system, believed to be the first of its kind in the country, has been set up at Malakpet race course, Hyderabad. The system is being used for races held at Hyderabad as well as for inter-venue betting.

The system is monitored and controlled by two ORG supermini computer systems. The two computers are connected by a local area network. In the event of failure of one system, the other system automatically takes over. The system supports over 230 specially designed betting terminals and has a provision for supporting 200 more terminals.

Security checks, validation of data, restart procedures, and fast response to the betting person (punter) are among the notable features. The system enables the punter to obtain tickets on any pool, of any combination and of any denomination at any of the selling windows. It also offers encashing facilities for winning tickets at any of the payout windows. In addition to betting functions, the system also provides cash tally statements, analytical statements of each pool and race and on line display of odds at regular intervals. The complete on-line software has been developed by ORG Systems and the Hyderabad Race Club.

Computer Syllabus

The Union government is finalising a standard syllabus for computer education programmes, especially in the area of programming. The syllabus, being examined by the All India Technical Education Council, will be announced shortly. Many recognised computer education courses would become avail-

able after the formulation of the syllabus. At present, most of the computer courses conducted by private institutes are not recognised for want of a standard syllabus.

Guided Vehicle

The Project and Consultancy group of the BEL has designed and manufactured an Automated Guided Vehicle for industrial application. AGV is an intelligent, driverless, three-wheel transport vehicle moving at a speed of 1.5 km per hour with a maximum load of 100 kg to a distance of 10 to 15 km continuously. AGV is powered by two rechargeable maintenance-free batteries which may be used continuously for eight to ten hours.

AGV is being used in the communication equipment division of BEL's Bangalore factory for transporting high frequency transceivers from assembly to

testing. It moves on a pre-determined path, in response to commands given by the in-built microprocessor-based controller. Steering signals are received from a signal generator through a wire buried in the ground. Sensors detect any obstruction and the vehicle automatically stops at such instances.

Recovery in chip industry

Semiconductor companies fared better in 1987 than they have since the market slump, according to Dataquest. Many companies grew faster than the market, some showing growth rates that doubled and even trebled the overall industry growth rate.

Dataquest estimates that semiconductor revenue grew 24.3 per cent over 1986 to reach \$36.6 billion. Japanese companies had 48% of the world market; North American companies 21.7%; and European companies 11%.

RANK		COMPANY	REVENUES		% CHANGE
1986	1987		1986	1987	
1	1	NEC	2,638	3,193	21.0%
3	2	Toshiba	2,276	2,939	29.1%
2	3	Hitachi	2,307	2,781	20.5%
4	4	Motorola	2,025	2,450	21.0%
5	5	Texas Instruments	1,781	2,125	19.3%
6	6	Pujitsu	1,365	1,899	39.1%
8	7	Phillips-Signetics	1,258	1,597	26.9%
11	8	Intel	991	1,500	51.4%
10	9	Mitsubishi	1,136	1,481	30.4%
9	10	Ratsushita	1,206	1,479	22.6%

Note: All revenues rounded

source: Dataquest

Top ten semiconductor suppliers world-wide.

	1986	1987	Annual Growth
Phillips-Signetics	\$ 820	\$ 969	18%
* SGS Thomson (1)	546	535	(2%)
Texas Instruments	489	525	7%
Motorola	425	501	18%
* Siemens (2)	396	446	13%
* National Fairchild (3)	338	382	13%
Intel	214	295	38%
NEC	229	258	13%
* AMD-MMI (4)	220	246	12%
ITT	215	243	13%

Top ten European semiconductor suppliers.

BALANCED LINE DRIVER AND RECEIVER

These high-quality audio circuits are intended to overcome all the problems caused by noise picked up by long unbalanced signal lines between signal sources and amplifiers. Applications can be found in public address systems, studios, active loudspeakers, mixer desks and intercoms.

The principle of balanced transmission of audio signals is relatively simple as shown in Fig. 1. The unbalanced signal from, for example, a preamplifier is applied to an unbalanced-to-balanced converter, which drives two output lines. One of these carries the inverted, the other the non-inverted signal. Noise picked up by the cable between the line driver and the receiver is superimposed on both AF signals. The complementary phase AF signals are added in the line receiver to give an unbalanced output signal, which is a copy of the signal fed to the line driver. In this process, noise is effectively eliminated because its phase is identical on both input lines of the receiver.

In studios, practically all lines for interconnecting equipment are of the balanced type. Balanced-to-unbalanced conversion and vice versa is usually effected with the aid of high-quality transformers. Unfortunately, these are hard to obtain and relatively expensive devices, and for this reason an alternative based on semiconductors is offered here.

Line driver

The circuit diagram of the line driver is given in Fig. 2. The unbalanced input signal is applied to buffer A_1 . This drives a non-inverting amplifier, A_2 , and an inverting amplifier, A_3 . Both opamps are configured for an amplification of about 2. The amplification is $1+R_1/R_2$ in the case of A_2 , and $-[(R_1+R_2)/R_3]$ in the case of A_3 (notice that the minus sign denotes inversion of the input signal, not attenuation). Resistors R_4 and R_7 correct error voltages caused by the quiescent input currents of inverting opamps A_1 and A_3 . Capacitors C_7 , C_8 and C_9 ensure very low distortion and stable gain up to the -3 dB roll-off frequency of 350 kHz. The opamps of the type stated in the circuit diagram give an output noise level of about $20 \mu V_{rms}$. This performance can be equalled by more com-

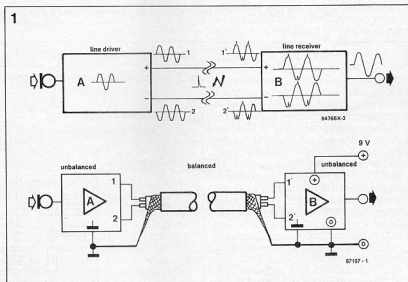

Fig. 1. Noise on long cables between audio equipment can be eliminated by the use of a balanced line driver and receiver.

monly found opamps such as the Type NE5534 (instead of the OP-27) and the Type NE5532 (instead of the OP-227), but only if all resistors in the circuit are ultra-low noise types with a tolerance of 0.1% or better to guarantee equal amplitudes of the balanced output signals.

Line receiver: introducing the AMP-01

Special attention should be paid in the receiver design to low overall distortion. There are, however, awkward constraints to take into consideration. The most important of these are the common-mode rejection of the opamp used, and cable capacitance. It is, therefore, necessary to use an amplifier that is geared to compensation, not amplification, of these sources of distortion.

The Type AMP-01 precision instrumentation amplifier from PMI should meet with this requirement. The AMP-01

houses 4 interconnected opamps that amplify the potential difference between the input pins by a factor that can be accurately defined. The internal structure of the AMP-01 is shown in Fig. 3. Since the device is essentially an instrumentation amplifier, it rejects signals common to both inputs. Unlike the complementary AF signals, noise induced on the balanced line between driver and receiver is of the same phase and amplitude at both inputs of the line receiver. Hence, it is common to both amplifier inputs, so that it is effectively suppressed at the output.

In contrast to an operational amplifier, an instrumentation amplifier requires precise internal feedback. In the AMP-01, current feedback is used. This approach has significant advantages over resistive feedback:

- High common-mode rejection (CMR): approx. 130 dB at a gain of 1,000.

- Closed loop amplification, A_{VCL} , can be set by the ratio of only two external resistors: $A_{VCL} = 20R_{15}/R_{16}$. This allows any practical gain to be set with high precision and low gain-temperature coefficient.
- The current feedback design is immune to CMR degradation when series resistance is added to the reference input. A small (trimmable) offset change results from added resistance, e.g., a printed circuit track.

Close tolerance low-drift thin-film resistors are integrated on the AMP-01 substrate to minimize output offset drift with temperature.

Input transistors Q_1 and Q_2 feed active loads, so that the amplification of this stage is about 4,000. Output amplifier A_1 is a 2-stage circuit offering an amplification of 50,000 in a $100\ \Omega$ load. The open-loop gain of the AMP-01 is about 2×10^6 . Stability and linearity of the device are excellent, also at relatively high closed-loop gains.

Ion-implanted super-beta transistors are used in combination with a patented bias-current cancellation circuit. Input quiescent current remains below 15 nA over the temperature range -25°C to $+85^\circ\text{C}$. A new geometry is used for the input transistors, resulting in an input noise of only $5\ \text{nV}/\sqrt{\text{Hz}}$ at a gain of 1,000. This noise includes contributions from the gain-determining and overload protection resistors. The input stage achieves an offset voltage drift of less than $0.3\ \mu\text{V}/^\circ\text{C}$.

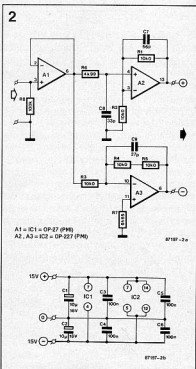

Fig. 2. Circuit diagram of the balanced line driver.

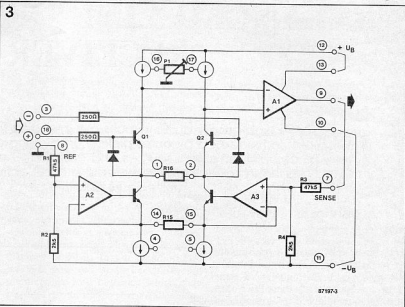

Fig. 3. Internal structure of the Type AMP-01 precision instrumentation amplifier from PMI.

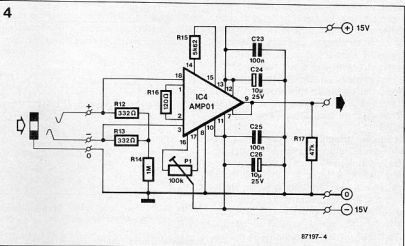

Fig. 4. Circuit diagram of the balanced line receiver.

The AMP-01 uses a special circuit for compensation of the load capacitance, ruling out any likelihood of instability over a wide range of practical gain. The high output current capability of $90\ \text{mA}_P$ allows the slew-rate of $4.5\ \mu\text{s}$ to be maintained with load capacitance as high as $15\ \text{nF}$.

The balanced line receiver has a 3 dB bandwidth of about 30 kHz. Noise level at the output was measured at $5.3\ \text{mV}_{\text{rms}}$ with inputs not connected, and $3.5\ \text{mV}_{\text{rms}}$ with inputs briefly connected to ground.

Power supply

The circuit diagram of the balanced line receiver is shown in Fig. 4. Resistors R_{15} and R_{16} are dimensioned for an amplification of about 940. The value of R_{15} may be increased to reduce amplification as required for a particular application. The input offset voltage is set to nought with the aid of P_1 . The symmetrical supply rails to the AMP-01 are decoupled with parallel combinations of a solid and an electrolytic capacitor. The potentials at the differential inputs of the chip are fixed with R_{12} - R_{13} - R_{14} .

The power supply shown in Fig. 5 should be familiar to constructors of previous high quality audio projects carried in this magazine. A number of readers have queried the use of the Type LM325 in this supply, and a short description of this device is, therefore, given below.

The LM325 can supply equal symmetrical output voltages whose absolute value is accurate within 1%. Without external series regulator transistors, the device

achieves a load regulation of 0.06% at a maximum output current of 100 mA. On board the IC are a current limiter and an overheating protection circuit. The onset point of the current limiter is defined by an external resistor. Quiescent current consumption of the LM325 is only 3 mA, while maximum input voltage is ± 30 V. This makes it possible, in many cases, to feed the regulator direct from the existing symmetrical supply in the power amplifier. Bridge rectifier $D_1 \dots D_4$ incl. (B) and rattle suppression capacitors $C_{10} \dots C_{13}$ incl. may then be omitted, but due attention should be paid to the working voltage of C_{14} and C_{16} .

Parts list

Resistors:

$R_1 \dots R_5$ incl. = 10K F
 R_6 = 4K9 F
 R_7 = 6K5 F
 R_8 = 100K F
 R_9 = 2R7 J
 R_{10} = 2R2 J
 R_{11} = 820R J
 $R_{12}; R_{13}$ = 332R F
 R_{14} = 1M F
 R_{15} = 5K62 F
 R_{16} = 120R F
 R_{17} = 47K J
 P_1 = 100K preset H

Note: resistor values are coded to BS1852: suffix F=1%; J=5%; K=10%.

A range of high stability, low-noise resistors is available from AudioKits Precision Components.

Capacitors:

$C_1; C_2; C_4; C_6$ = 10 μ ; 25 V; radial
 $C_3 \dots C_6$ incl.; $C_{16}; C_{17}; C_{19}; C_{20}; C_{23}; C_{25}$ = 100n
 C_7 = 56p
 C_8 = 33p
 C_9 = 27p
 $C_{10} \dots C_{13}$ incl. = 22n
 $C_{14}; C_{16}$ = 1000 μ ; 25 V; radial
 C_{18} = 1 μ 0; 16 V; radial
 $C_{21}; C_{22}$ = 1000 μ ; 16 V; radial

Semiconductors:

$D_1 \dots D_4$ incl. = 1N4001
 D_7 = LED
 $T_1; T_2$ = BD241
 IC_1 = OP-27*
 IC_2 = OP-227*
 IC_3 = LM325N
 IC_4 = AMP-01*

* Precision Monolithics Incorporated. UK distributors are listed on InfoCard 508 (EE May 1987).

Miscellaneous:

PCB Type 87197

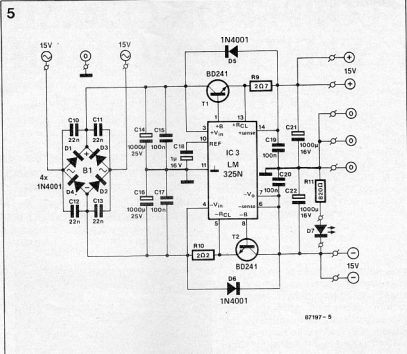

Fig. 5. The symmetrical power supply is a design based on precision voltage regulator Type LM325.

Construction

The three circuits discussed are accommodated on a single printed circuit board, whose track layout and component overlay are shown in Fig. 6. Depending on the application of the balanced line driver and receiver, the PCB may be cut in two or three to enable fitting the circuits in the relevant locations.

The screened, balanced, cable between the line driver and receiver is connected as shown in the lower drawing of Fig. 1. It is recommended to use high-quality cable and XLR (Canon/Neutrik) connectors.

The functional description of the Type AMP-01 is based on information provided in *Linear and Conversion Products. 1986/1987 Data Book*. Precision Monolithics Incorporated.

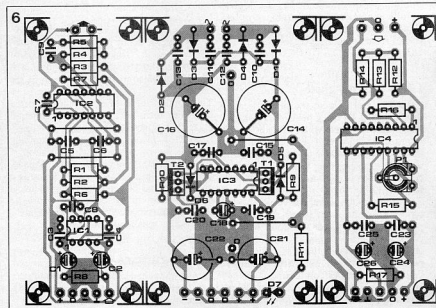

Fig. 6. Printed circuit board for building the line driver, receiver and power supply.

COPPER-ON-CERAMIC MICRO-ELECTRONIC TECHNOLOGY

by Harry Cole, CEng, MIERE

As the technology of modern micro-electronic circuitry advances, so too does the need to convey digitally coded signals at ever increasing rates. This requirement assumes considerable importance in the multi-layer type of circuit board where many widely spaced ICs have to be interconnected with negligible loss of amplitude.

Traditionally, gold has been used for interconnection purposes in chip carriers intended for military and aerospace applications where high reliability is of prime importance. Unfortunately, the relatively high electrical resistivity of gold ($0.02 \mu\Omega \text{ m}$) and the need for thinner interconnections makes this material unsuitable for the interconnection of densely packed ICs.

Copper, although lacking some of the desirable properties of gold, has a resistivity of $0.016 \mu\Omega \text{ m}$ which is considerably lower and has good solderability. It is much cheaper and has good adhesion properties when bonded to circuit board materials.

The Micro-electronics Technology Centre of British Aerospace's Air Weapons Division at Hatfield has devoted considerable research into the use of copper interconnections laid down on substrates formed of aluminium oxide ceramic. It has developed a fully documented repeatable process that can produce substrates in a variety of flat rectangular sizes up to $152 \text{ mm} \times 183 \text{ mm}$.

Glass sealing glaze

After being processed, the substrate can be machined by laser beam to virtually any shape, complete with access holes as required. The circuit interconnections are laid down on the ceramic substrate using screen printing technology, and circuit tracks as thin as 0.18 mm can be produced.

Each circuit board may have up to six separate conducting layers, including gridded power and ground (earth) planes, the top layers containing the electrode attachment pads for the components to be fitted. Electrical isolation between the copper conducting layers is achieved by printing from two to five layers of dielectric material, the final thickness being tailored to suit the required insulating properties of the circuit

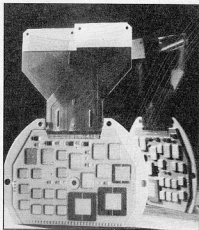

Double sided copper-on-ceramic electronic module.

being constructed.

Interconnection between various metal layers is achieved by the printing of copper connector "slugs" in an isolation window cut into the dielectric insulation. This form of connection is known as a "via".

The final printed layer of each board takes the form of a high glass content glaze that effectively seals all preceding conductor layers from environmental hazards during subsequent manufacturing processes. A complete circuit may undergo as many as 50 screen printing operations and 30 separate firing cycles. During each firing cycle the printed substrate is subjected to a temperature profile that peaks at about 900°C .

Special furnace

In the atmosphere of a conventional furnace such a temperature would cause the printed copper to oxidize, with consequent degradation of its electrical performance and solderability. For this

reason, copper printed substrates are fired in an inert nitrogen atmosphere containing a critically controlled doping level of oxygen. The special furnace was designed in-house by the Micro-electronics Technology Centre at Hatfield.

When manufacture is complete, the printed substrate is subjected to a rigorous programme of bare-board electrical tests to verify the correctness and continuity of its circuit and connection patterns.

A wide variety of components can be accommodated on the printed substrate, including ceramic and tantalum chip capacitors and leadless chip carriers containing up to 68 connection pins (this capability will shortly be expanded to accommodate larger chip carriers with up to 84 pins). The chip carriers referred to here are rectangular in shape and have connection pads located along all four sides spaced at pitch intervals of 1 mm or 1.27 mm .

A particularly valuable advantage of packaging ICs inside chip carriers is that it enables them to be fully tested and qualified prior to being mounted on the ceramic circuit board.

Easier flux clearance

Once the ICs and components have been assembled on the board they are restrained by an elastomeric fixative and then soldered into position by the technique of reflow soldering. Because the body of the chip carrier is made from a ceramic material similar to that from which the circuit substrate is made, it has similar thermal characteristics and the soldered joints are not subjected to significant thermally induced stresses. The process developed by the Micro-electronics Technology Centre for the attachment of components to circuit boards results in a controlled stand-off (board clearance) height for the mounted components of about 380 mm .

The advantages that come from such a clearance are that they ease the clearing of flux residues from under the components and make possible the close inspection of solder joints by either normal visual means or new techniques such as X-ray microfocus. This type of inspection is not possible without stand-off height.

The complete clearance of flux residues is highly desirable since the presence of such contaminants can pose a serious risk to long-term reliability.

External connections to the circuit board are made by a surface-mounted connector with soldered joints formed by reflow soldering.

There are essentially two methods of assembly adopted by the Micro-electronics Technology Centre. The first makes use of a single sided board fitted with metal edge supports so that the ceramic board can be inserted directly into a standard Eurocard rack. The second method takes advantage of the good thermal conductivity of the aluminium oxide ceramic substrate and uses it as a heat sink for two fully assembled ceramic boards mounted back-to-back on either side of an aluminium core plate.

Punishing tests

The plate functions as both a structural support and a very efficient heat sink. This form of assembly is used where space is restricted. The heat-removing properties of the assembly are further enhanced by the use of high thermal conductivity material for the elastomeric adhesive employed for component placement and for attaching the boards to the core plate.

Circuit board assemblies using the back-to-back method of mounting have been subjected to an independent series of tests carried out by the Components Evaluation Department of British Aerospace's Air Weapons Division.

The tests, which are punishing to any electronic assembly, have included operating temperatures ranging from -55°C to 125°C ; damp heat storage at 85% relative humidity at 85°C for 1000 hours; a one minute acceleration of a gravitational force (g) of 1000 (9806 metres per second per second); 400 temperature cycles ranging from -55°C to 125°C with ten minutes dwell time and five minutes transfer time; and 100 cycles of ambient power cycling for 15 minutes each side when dissipating 130 mW/cm^2 . As if this was not enough, low frequency power cycling was imposed at

130 mW/cm^2 , and switched on and off repeatedly for 20 temperature cycles.

Automated manufacture

In addition, high frequency power cycle was superimposed on 70 temperature cycles while power at 130 mW/cm^2 was switched on and off at one minute intervals.

In addition to its design and manufacturing capabilities at Hatfield, the Micro-electronics Technology Centre can also undertake the modification and repair of fully assembled boards. It can, for example, remove and replace all sizes of leadless chip carriers, chip capacitors, chip resistors and flat conductor cable, and cut and isolate copper track.

Work is under way to commission an automated production facility dedicated to the manufacture of copper-on-ceramic multi-layer modules using the operating experience acquired from the company's existing design and manufacturing service.

Micro-electronics Technology Centre, British Aerospace PLC, Air Weapons Division, Manor Road, HATFIELD AL10 9LL.

BREAKTHROUGH IN SUPERCONDUCTING MATERIALS

by Peter Hartley, MIMGTechE

One of the technological sensations of the past eighteen months has been the race towards the first effective room temperature superconducting material. Apart from achieving reliability, one of the major problems is how to fabricate useful products on a commercial basis from the new breed of ceramic materials.

Basic Volume (1), a specialist sensors and electronics materials company, claims to have produced the world's first superconducting solenoid in a ceramic material. This development could start an avalanche of applications for superconducting ceramics.

Superconductivity, the phenomenon in which a material loses all its resistance to electric current, was until comparatively recently observed only at temperatures below -250°C . This required the use of liquid helium as a coolant.

In February 1987, however, Dr Paul Chu at the University of Houston in the United States discovered a ceramic compound that superconducts at -183°C ,

consisting of yttrium, barium, copper and oxygen. This opened up the possibility of using liquid nitrogen, which boils at -196°C and is much cheaper to use than helium as a coolant.

Single-turn solenoid

Basic Volume, which manufactures solid-state chemical sensors and signal process electronics, was actually producing some of the materials used for superconductivity researches enabling the company's Dr Tim Tavares and his team to experiment with materials that were available immediately.

In March 1987, the company was able to

produce samples of $\text{Y}_{1.8}\text{Ba}_{0.4}\text{CuO}_{7-x}$ with a superconductivity transition temperature of -213°C , and this was rapidly improved upon with its so-called YBC0123 compound in April.

On 24 April, after three previously unsuccessful attempts, the company managed to produce a ceramic superconducting single-turn solenoid. This was made of YBC0123, measured 90 mm long with a 14 mm outside diameter and a radial thickness of 3 mm. The device's material was also, unlike some other similar materials, stable in water.

This development means that many commercial applications of the new nitrogen-cooled ceramic supercon-

ductors are months rather than years away. Among the uses immediately envisaged are: nuclear magnetic resonance equipment, magnetic mineral separation, magnetic bearings, high torque dc electric motors, spin resonance spectroscopy equipment, and electronic imaging apparatus.

Metal matrix composites

Dr James Watson of Southampton University, a specialist in the magnetic separation of minerals, has been supplied by Basic Volume with tubes of $YBa_2Cu_3O_{6.57}$ superconducting ceramic. These tubes, which are 37 mm in diameter, 90 mm long and 1 mm thick, superconduct reliably at temperatures up to -196°C .

He finds that the material supplied to him by Basic Volume provides a much higher density than competitive products — 90% of the theoretical maximum — and allows current carrying capacities up to $5 \times 10^4 \text{ A/cm}^2$.

Superconductors may have made the technological headlines during the past year, but an equally exciting engineering materials development has been that of the commercialization of metal matrix composites.

To most engineers, the word composites conjures up the image of plastics reinforced with glass or carbon fibres. In these materials, the fibres confer strength to an otherwise mechanically weak material. The fibres take the load and the polymer matrix serves to distribute this load equally between them.

Large capacity production

The same principle is used in a family of new materials — metal matrix composites (MMCs) — in which a metallic phase (the matrix) is reinforced by very strong ceramic or metal fibres, whiskers or particles.

In 1984, the British Collyear Committee Report on new engineering materials and processes states that the key areas for development in MMCs were concerned with the technology of producing them in tonnage quantities.

This is an aim towards which the Metals Technology Centre at the Harwell Laboratory⁽²⁾ is deeply committed. The so-called MMC Club, organized by, and centred on, Harwell, is carrying out research into titanium-based MMCs within the framework of the European Community's BRITE (Base Research in Industrial Technologies) programme. Cray Advanced Materials⁽³⁾, backed by the Cray Electronics Group, was formed some 18 months ago to exploit MMCs commercially. The company operates under a licensing agreement from Britain's Ministry of Defence and uses the patented liquid pressure forming

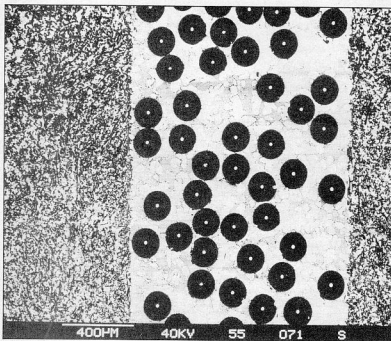

A metal matrix composite containing a hybrid of short $3 \mu\text{m}$ diameter alumina fibres and silicon carbide coated boron fibres.

(LPF) process, a new technique for making components from fibre-reinforced metals.

Producing complex shapes

Commercial applications of MMCs, currently at the feasibility demonstration stage, include: components for the automotive industry such as pistons, connecting rods, brake callipers, and wheels; gas cylinders; marine propellers; armour plate; lead battery plates; bicycle frames; robotic arms; overhead pantographs for electric trains; and specialist tools.

The LPF process is a technique for the production of ceramic fibre-reinforced metal components to net shape or near net shape, with excellent dimensional tolerances and exceptional mechanical properties.

Various types of ceramic fibre, such as silicon carbide, alumina, boron and carbon, can be used with metals such as aluminium, magnesium, lead zinc or copper alloys.

The Cray LPF process can be used to produce complex shapes that vary in size from a few centimetres up to $2 \text{ m} \times 1.5 \text{ m} \times 1.5 \text{ m}$. It is essentially a single-batch process that produces a net-shaped reinforced component with tolerances in the region of $\pm 0.2\%$. Production times are relatively short and die costs low for the volume output.

Glass ceramics

Ceramic Developments (Midlands) Ltd (CDML)⁽⁴⁾ is carrying out a range of investigations into the engineering applications of glass ceramics. These differ from true glasses in being polycrystalline ceramics resulting from the crystallization of glasses.

They differ from traditional engineering ceramics in that the starting material is nearly always completely amorphous and not the product of the liquid phase sintering of ceramic precursors.

CDML has carried out an internal development programme aimed at producing a range of photomachinable glasses and glass ceramics with differing expansion coefficients in the range $7 \times 10^{-6}/^\circ\text{C}$ to $11 \times 10^{-6}/^\circ\text{C}$.

Augmented by CDML-funded research at Sheffield University this has led to the development of a useful range of materials with potential for:

- micro-electronics substrates where high densities at fine holes are needed for interconnection;
- plasma display panels;
- competition with low volume production of ceramic components but giving higher precision without prohibitive tooling costs.

Potential applications

The Department of Trade and Industry has recently awarded the company a

grant of £28,000 to further this project. Glass ceramics developed at CDML show abrasion resistances comparable to that of boron carbide. Potential applications for this material are pipe linings, the coatings for moving parts operating in abrasive environments, and possibly the plasma spraying of large metal components in situ. According to Dr Ronald Jones, CDML's managing director and founder, the firm is now at the stage of being able to cast glass ceramic pipes centrifugally.

One of the most impressive results of work at CDML has been the successful development of glass ceramic armour that shows a similar ballistic performance, thickness-for-thickness, to that of alumina, when used as a protection against 7.62 mm calibre rifle bullets. The real advantages, however, are weight saving — since the ceramic glass has a density of only 2.4 g/cm³ as opposed to 3.8 g/cm³ for alumina — and relatively low processing costs.

Screening equipment

A further useful development at CDML has been the production of very high-quality glasses and glass ceramics by Sol-Gel technology. This involves polymerizing the silicate networks from ethoxysilanes by condensation polymerization. The resultant glasses have a very high surface area tension and can be densified by heat treatment at about 500 °C. This enables glass to be made for catalyst supports, barrier layers and coatings, which are almost impossible to produce by conventional fusing of oxides.

CDML is also researching the use of glass ceramic materials for use as strong, heat-dissipating substrates for thick-film circuitry. The company has formed a consortium with Thorn-EMI, Lucas, Wade and Engelhard, to develop and exploit its work in this area.

Another area of United Kingdom electronics materials development has been in the field of screening equipment against electromagnetic interference (EMI) and radio frequency interference (RFI). Thus, in anticipation of new and tougher European Community legislation on allowable levels of electromagnetic noise emissions from equipment, Shipley Europe⁽⁵⁾ has introduced a new EMI shielding technique based on the firm's well established electroless plating technology.

Longlasting adhesion

The chemical process involved deposits uniform thicknesses of copper and nickel coatings on all component surfaces to give, it is claimed, a 40 dB improvement in attenuation of EMI over previous methods such as arc spraying of zinc or the use of conductive nickel paints.

Since copper is a better electrical conductor, it provides maximum protection with a fraction of the thickness used with other methods, resulting in lighter fabrications and greater cost savings. Shielding effectiveness is greater than 80 dB with a copper thickness of only 625 µm.

Total immersion in a series of chemical treatment baths ensures that all surfaces, no matter how complex, receive a uniform coating of metal. Pre-cleaning and etching give long lasting coating adhesion and ensure, it is claimed, that electroless shields will not crack or flake the way some arc sprayed zinc coatings can.

The process can be used for both solid injection moulded plastics parts and structural foam plastics components, made from ABS, polycarbonate, polyethylene oxide, polystyrene and many other polymers. A final coating of electroless nickel protects against corrosion, abrasion and provides a suitable base for cosmetic finishing.

Elastomeric gaskets

Dowty Seals⁽⁶⁾ claims to have achieved a breakthrough in EMI/RFI screening with its new Dowshield range of conductive elastomeric seals and gaskets. This range incorporates seven different compounds and three types of seals — Dowprint, moulded seals and extruded profiles.

Four of the compounds are used specifically for the production of flat elastomeric gaskets by the company's Dowprint screen printing process. For this, there is a choice of silicon or cross-linked vinyl polymers, loaded with conductive silver or silver-plated nickel particles. They provide a volume resistivity as low as 0.0004 Ω/cm and a signal attenuation as high as 106 dB by the American Society for Testing Materials (ASTM) test method.

The moulded seals and extruded components employ silicon or fluoro-silicon materials loaded with silver-plated nickel.

Radiation dosimeter

Another interesting innovation on the plastics front is the development of 20% and 30% glass fibre-reinforced, nuclear radiation resistant, polyethersulphone — Victrex PES — by ICI⁽⁷⁾.

The British custom-moulding company, Jarzon Plastics⁽⁸⁾ has added these materials to its range of engineering plastics. It has collaborated with the GEC company to design and produce nuclear radiation dosimeters — worn on the wrist — in one of these materials, which allows gamma rays to penetrate. After exposure to radiation, the dosimeters are slotted into a drawer of the same material, which in turn is slotted into a reader to obtain the radiation level readout.

References:

1. Basic Volume Ltd, 13a Cotswold Street, London SE27.
2. Harwell Laboratory, Harwell, Didcot, Oxfordshire OX11 0RA.
3. Cray Advanced Materials Ltd, 6 Armoury Road, Lufton Trading Estate, Yeovil, Somerset BA22 8RL.
4. Ceramic Developments (Midlands) Ltd, St Marks Road, St James Industrial Estate, Corby, Northamptonshire NN18 8AN.
5. Shipley Europe Ltd, Herald Way, Coventry CB3 2RQ.
6. Dowty Seals Ltd, Ashchurch, Tewkesbury, Gloucestershire GL20 8JS.
7. Imperial Chemical Industries PLC, Petrochemicals & Plastics Division, PO Box 6, Bessemer Road, Welwyn Garden City, Hertfordshire AL7 1HD.
8. Jarzon Plastics Ltd, Golden Crescent, Hayes, Middlesex UB3 1AQ.

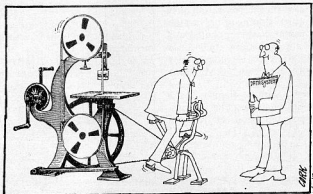

VLF CONVERTER

Build this 10 MHz up-converter if you are interested in receiving signals from time standard, FAX, RTTY and other utility stations operating in the kilometric bands.

The frequency range from 30 kHz to 150 kHz is generally referred to as the Very Low Frequency (VLF) band. It is used relatively little, because high transmitter powers and large aerial systems are required, which generally give a relatively small coverage (typically about 300 to 1000 km). For a number of applications, this is not considered a disadvantage, however. Propagation of VLF waves is highly predictable, since there is virtually no atmospheric reflection: the transmitter range is, therefore, fairly accurately defined. VLF signals travel almost exclusively via the so-called ground wave, while the ground-ionosphere space acts as a waveguide. Thanks to this property of the VLF band, received signals are usually free from phase shift and amplitude variation (fading), so often found on the shortwave bands. The VLF band is well suited to medium-range, one-way data communication, such as time standard transmitters (Rugby GBR, Rugby MSF, Mainflingen DCF77, Prangins HBG), meteorological facsimile, submarine communication, and telex networks. One disadvantage of the VLF band is the huge aerial system required at the transmitter side. Aerial systems of several square kilometres, and with multiple transmitter feed points, are not uncommon, yet attain a radiation efficiency of only a few percent. At the receiver side, due account should be taken of the high level of man-made noise (computers, neon tubes, TV sets and other electrical appliances). In most cases, the so-called long wire is the only feasible aerial at the receiver side. Thirty metres or more of sloping or horizontally running insulated wire, mounted well away from the previously mentioned sources of interference, is recommended for serious experiments in receiving VLF transmissions.

Generally, the lower the frequency, the rarer and more interesting the stations. Not every communications receiver can be tuned as low as 15 kHz, but this is made possible by the up-converter described here. It effectively converts the frequency range from about 15 kHz...300 kHz to 10 MHz, so that the CW, RTTY, FAX, AM or SSB

facilities of the communication receiver tuned between 10.000 and 10.300 MHz can be exploited to receive VLF transmissions.

Circuit description

The VLF converter is an application of the Type NE602 active double balanced mixer and oscillator, whose block diagram is shown in Fig. 1. The chip requires only a handful of external components to make a good-quality up-converter.

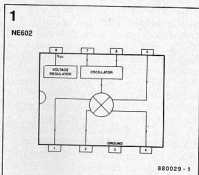

Fig. 1. NE602 integrated active double-balanced mixer/oscillator.

The circuit diagram of the converter is given in Fig. 2. The function of the circuit is to convert the frequency range from 15 kHz to about 300 kHz to an equally large band starting at 10 MHz. The SSB/CW/FAX/RTTY receiver connected to the output of the converter is tuned between 10.015 and 10.300 MHz. A VLF station such as Rugby MSF is, for example, "received" at 10.060 MHz. The VLF aerial signal is passed through low-pass filter L₁-C₁-L₂-C₂-L₃-C₃ that defines the input frequency range (15 kHz...300 kHz). Transistor T₁ forms an impedance transformer between the filter output and one RF input of the active mixer in IC₁. The NE602 is set up in an asymmetrical configuration here. RF input pin 2 is bypassed to ground with C₇, while P₁ is used for setting equal direct voltages at the RF inputs to optimize mixer balance. The output frequency of the local oscillator on board the NE602 is set to 10 MHz with the aid of an external quartz crystal, X₁. Trimmer C₁₁ provides a means for accurately setting the LO frequency to 10.000 MHz, so that the tuning scale on the receiver corresponds to the true received frequency, ignoring, of course, the "10" preceding the kHz digits in the read-out.

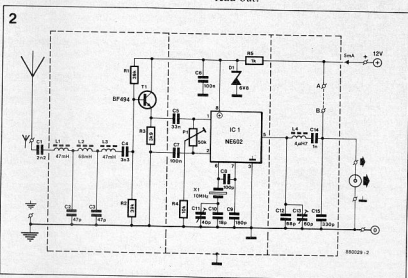

Fig. 2. Circuit diagram of the VLF up-converter.

ATTENTION

**PCBs
& Set of COMPONENTS**

for projects are normally available with

precious® ELECTRONICS CORPORATION

52-C Proctor Road, Bombay-400 007 Phones: 367459/369478

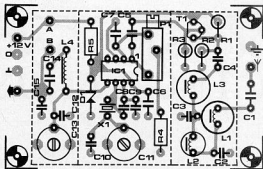

Fig. 3. Printed circuit board for the VLF converter.

The output of the active double balanced mixer is a single-ended configuration. The up-converted frequency band is filtered in pi-section $C_{12} + C_{13} - L_4 - C_{14} - C_{15}$ to suppress spurious mixer products. The low-frequency roll-off point of the filter is set to about 10 MHz by trimmer C_{13} . It should be noted that the mixer also generates an image band between 9.985 MHz (10 - 0.015) and 9.700 MHz (10 - 0.3), but this of little consequence. The converter is fed from a regulated 12 V source, either via separate supply wires (do not fit link A—B), or via the downlead coax to the receiver (fit link A—B), and make sure that the receiver output voltage is between 10 and 15 V). The mixer/oscillator and preamplifier transistor are fed from a 6.8 V rail created with stabilizer R_5 -D.

Construction and alignment

The VLF converter is a simple to build project. The printed circuit board is a double-sided, but not through-plated, pretinned type—see Fig. 3. Commence the construction with fitting 15 mm high brass or tin metal sheet screens as shown on the component overlay. Component leads shown without a small circle are soldered at the track side of the board, and to the ground area provided on the component side. Radial inductors L_1 , L_2 and L_3 are ferrite encapsulated types from Toko. The mixer/oscillator, IC_1 , is fitted direct onto the PCB (do not use a socket). Drill a 2 mm dia. hole in the screen to give access to the spindle of multitrurn preset P_1 . Finally, fit soldering terminals for the input, output and supply connections. Install wire link

Parts list

Resistors ($\pm 5\%$):

$R_1, R_2 = 39K$
 $R_3 = 3K9$
 $R_4 = 10K$
 $R_5 = 1K0$
 $P_1 = 50K$ multitrurn preset

Capacitors:

$C_1 = 2n2$
 $C_2, C_3 = 47p$
 $C_4 = 3n3$
 $C_5 = 33n$
 $C_6, C_7 = 100n$
 $C_8 = 100p$
 $C_9 = 180p$
 $C_{10} = 18p$
 $C_{11} = 40p$ trimmer
 $C_{12} = 68p$
 $C_{13} = 60p$ trimmer
 $C_{14} = 1n0$
 $C_{15} = 330p$

Inductors:

$L_1, L_3 = 47mH$ ferrite encapsulated choke for radial mounting: Toko Type 181LY-473 (Cirkit stock no. 34-47302).
 $L_2 = 68mH$ ferrite encapsulated choke for radial mounting: Toko Type 181LY-683 (Cirkit stock no. 34-68302).
 $L_4 = 4\mu H$ axial choke.

Semiconductors:

$D_1 =$ zenerdiode 6V8; 400 mW
 $IC_1 = NE602$ (available from CSI Electronics)
 $T_1 = BF494$ (Maplin order no. QQ19V)

Miscellaneous:

PCB Type 880029
 $X_1 = 10$ MHz quartz crystal; 30p parallel resonant.

A—B if the converter is powered via the coax cable to the receiver.

Set P_1 , C_{11} and C_{13} to the centre of their travel. Apply 12 V to the circuit, and check the presence of 6.8 V on pin 8 of IC_1 . Measure the direct voltage on pins 1 and 2, and adjust P_1 until both are held at an equal potential of about 0.8 V. Connect the receiver, and tune this to 10.000 MHz. Mode: CW, BFO off, or to the centre of its travel. Switch on the input attenuator, or select reduced RF input gain. Lower the frequency of the beat note heard to nought by adjusting C_{11} (zero beat). Connect the aerial to the VLF converter, and tune to a relatively strong transmission at

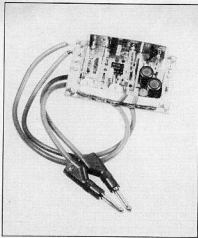

Completed prototype of the VLF converter. The screening fitted onto the component side prevents oscillation and spurious mixer products.

about 200 kHz (10.200 MHz on the receiver), e.g. Droitwich (AM). Reduce the input gain of the receiver, and peak C_{10} for optimum reception (this adjustment is relatively uncritical).

Stations and services

It should be noted that the VLF converter has some conversion gain, so that

Frequency	Station	Power	Service
16 kHz	GBR Rugby (UK)	60 kW	time signals during the 5 minutes preceding 03.00h, 09.00h, 15.00h and 21.00h.
50 kHz	RTZ Irkutsk (USSR)	50 kW	standard frequency.
60 kHz	MSF Rugby (UK)	50 kW	standard frequency & BCD time and date signals.
71 kHz	<i>not identified</i>		time signals.
75 kHz	HBG Prangins (SUI)	20 kW	BCD time and date signals.
77.5 kHz	DCF77 Mainflingen (FRG)	50 kW	standard frequency & BCD time and date signals.
117.4 kHz	DCF37 Mainflingen		meteorological facsimile.
134.2 kHz	DCF54 Mainflingen		meteorological facsimile.
139.0 kHz	DCF39 Mainflingen		photofacsimile.

Some stations that can be received below 150 kHz.

every care should be taken not to overdrive the communications receiver. It is, therefore, strongly recommended to make use of the fixed or variable RF attenuator provided on most receivers. The connection between the VLF converter and the unbalanced, low-impedance (50—100 Ω) receiver input must be made in coaxial cable to prevent breakthrough of strong signals in the 10 MHz band.

The frequency assignment used in the VLF band is roughly as follows:

- 15—100 kHz: submarine communications (CW), beacons and time standard transmitters;
- 100—150 kHz: RTTY (radio teletype), and meteorological facsimile services;
- 150—300 kHz: long-wave broadcast services and, occasionally, RTTY.

SIGNAL PROCESSING AND ELECTRONIC ENCRYPTION

by Brian P. McArdle

This article examines the effect of encryption operations on the usual understanding of signal processing.

Electronic signals are made secret by encryption operations. The original signals can be analogue or digital. For the purposes of this article analogue signals are complex waveforms made up of different frequencies. Digital signals are a sequence of pulses where each pulse can be identified as a particular bit (logic state 1 or 0) by reference to the voltage level, polarity, etc. They are also called mark and space pulses respectively. I do not intend to become involved in a detailed description of encryption, but to provide an over-view which should assist an electronics engineer or technician. For simplicity, the various encryption operations are considered to turn a signal

into another signal of the same category, i.e., analogue signals after a scrambling operation are still analogue signals. Elaborate systems where analogue signals are sampled, turned into digital signals which are encrypted and transmitted in digital form are not considered. The paper explains two simple examples which can be altered as required. The comments and conclusions are of a general nature and may require amendment according to particular circumstances.

Digital signal processing

Consider the encryption process il-

lustrated in Figure 1. This represents a typical arrangement for the encryption and transmission of confidential information between message centres, such as

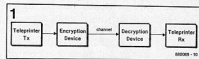

Fig. 1. Encryption of digital signals.

two embassies. If the teletypewriter uses the CCITT Number 2 Code, each character pressed on the key-board will be represented as 5 bits plus start and stop bits. The electronic word is transmitted in bit serial mode (one bit at a time) to

the encryption unit. For simplicity, we will assume that the start and stop bits are not encrypted which is the procedure used in most cipher machines. The 5-bit block can be encrypted as a single block or one bit at a time. These are called Block and Stream Encryption respectively. (Usually blocks are made up of 64 or more bits.) The reader is referred to Ref (1) for an analysis of the various encryption operations. These need not be examined in this article. The actual electrical connection between teleprinter and encryption device is a 20 mA current loop illustrated in Figure 2. The start pulse has the same duration as a data pulse. The stop pulse is 1.5 times the duration. Hence, the code is referred to as a 7.5 bit code. There are 31 possible combinations (2^5-1) because the state 00000 is not used. The normal speed is 50 or 75 baud. There are other codes with other interfacing arrangements but the overall concept demonstrated by this example holds.

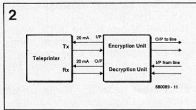

Fig. 2. Interfacing arrangement using 20 mA current loop.

The level of secrecy depends on the complexity of the encryption operation. This is usually varied by adjusting internal settings inside the device. Obviously, the same setting should not be used continuously. Otherwise the effect of the encryption operation would be cancelled or reduced considerably. An unauthorized listener (hacker) on the channel would probably know the arrangement but not the actual settings in use. There is always a very large number of possible settings in order to avoid deduction of a particular setting by trial and error. In cryptographic terms, the setting is generally called the key because it unlocks the information from confinement by a secrecy process. The reader is referred to Ref (2) for an analysis of the secrecy requirements of an encryption system. Basically it should not be possible to deduce the key by any method other than by trial and error. Hence the need for a very large set of possible keys. However, cryptosystems are not discussed in this article.

If the channel is a HF link, the output from the encryption unit becomes the audio input to the transmitter. This consists of 2 different tones with a frequency difference of 850 Hz between them. The upper frequency usually represents the '1' or mark pulse but this representation is sometimes reversed. This is known as Frequency Shift Keying (FSK)

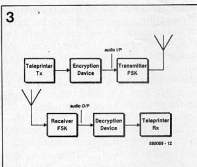

Fig. 3. Communications over a HF radio link.

and is explained in most modern text books on Telecommunications. It can be detected on most standard receivers by using Amplitude Modulation (AM) or Single Sideband (SSB). Obviously, the encryption unit must have the appropriate outputs to interface to the transmitter and not the same arrangement as the interface to the teleprinter. The reverse procedure is applied at the receiver where the audio output is fed to the decryption unit. There are many other possible arrangements depending on the equipment and type of channel.

Analogue signal processing

This is usually used to encrypt voice communications, such as over telephones and radio links. The encryption operation conceals the information contained in an analogue signal but the resulting encrypted signal is still in analogue form. A typical arrangement is shown in Figure 4. Usually, the

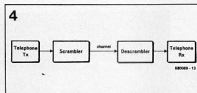

Fig. 4. Encryption of analogue signals.

scrambler unit cannot scramble and descramble simultaneously and consequently half-duplex operation must be used. The output from the scrambler is an analogue signal in the same frequency range as the original audio signal (refer to the assumptions in the opening paragraph of this article). A common method uses frequency inversion where parts of the analogue voice signal undergo an inverting operation which is controlled by a definite procedure inside the scrambler. The descrambler uses the same procedure and simply reverts the frequencies back to their original arrangement. The full operation is its own inverse which in turn facilitates implementation and use. However, analogue signal encryption is not considered to provide the same level of

secrecy as digital signal encryption. This is because the cascaded substitution-permutation operations that provide real secrecy are more easily implemented with groups of bits. This statement requires further explanation in order to tie down the full problem.

Consider a digital system again as shown in Figure 5. The permutation operation re-arranges the order of the bits. For example, bit 9 moves to the 4th position and so on. The substitution operation divides the permuted block into sub-blocks of 4 bits each which is replaced by another block (e.g. 0100 becomes 1010).

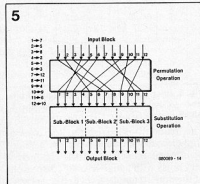

Fig. 5. Permutation-substitution operation.

Different replacement tables can be used for each sub-block. If these operations are repeated a number of times with different permutation and substitution tables, the entire process has a high level of secrecy. The complete operation is varied by changing the tables. The theory behind this procedure is explained in Ref (3) but need not be considered in this type of overview.

If the channel is a VHF radio link, the scrambled audio signal is used to modulate an RF carrier using the same methods of modulation as for unscrambled voice communications (AM and narrowband FM). There are other possible arrangements but they do not differ substantially from this example.

Communications channels

The quality of a channel can have a major effect on encrypted signals. Consider the arrangement in Figure 1 again. If the channel is noisy, a pulse could be corrupted sufficiently for a '1' to be detected as a '0' or vice versa. This means that a bit in an electronic word is incorrect and consequently the decryption operation will produce a wrong character. If this type of corruption does not happen too often, the person who ultimately reads the decrypted message will notice the errors and be able to alter the text accordingly. However, a serious problem does occur where a decryption operation uses successive bits of a message in some inter-dependent fashion. This means that a sequence of words

would be reproduced incorrectly because of a single error. A simple arrangement is illustrated in Figure 6. The output bit from the encryption operation becomes part of the operation to encrypt the next input bit. Thus, successive output bits are linked together. A single error could have a disastrous result at the decryption stage. This example only uses one bit in the feedback loop but some systems could be using as many as 64 or 128 bits.

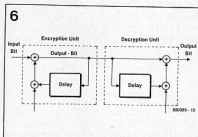

Fig. 6. Inter-dependence between output bits (the + sign refers to addition modulo 2, which is an Exclusive OR logic operation).

The reader is referred to Ref (4) on Cipherfeedback Mode which is a good example of this effect. If the channel is very noisy with a high level of corruption of the digital signals, a very reliable error detection/correction system must be installed between the encryption/decryption unit and the channel. The only alternative would be to transmit the information in plaintext without being encrypted which may not be satisfactory for the users.

Consider the example in Figure 4 again.

Although it was not stated in the original explanation, a synchronization signal would probably have to be transmitted at regular intervals in order that the descrambler can reverse the scrambling process in the correct sequence. If the channel is noisy, a noise pulse could be interpreted as a synchronization signal by the descrambler such that the output signals turn into unrecognizable rubbish. This may not actually happen too often, but when it does communications are totally blocked. Alternatively, the scrambled signals may be corrupted but this may only affect certain frequencies. Voice communication has a very high level of redundancy and even noisy messages can sometimes be understood by an experienced operator. However, in general analogue signal encryption requires a good channel for reliability. Otherwise it may simply not work.

Conclusions

There is an obvious problem with analogue signals. Remember that these are essentially little packets of different frequencies that together form the signals, which in turn become the information. The various operations of encryption, transmission over a channel and decryption must reproduce the original signals as accurately as possible. In reality, these are difficult requirements to satisfy. For example, to compensate for a noisy channel, the encryption operation may have to be simple and straight-forward, which in

turn reduces the level of secrecy. This could mean that the effect of encryption is to provide privacy rather than secrecy (in this context, privacy means secrecy against members of the general public rather than code breaking organizations, such as the National Security Agency in the U.S.). However, encryption operations that require bits, such as the Data Encryption Standard, are much more flexible. They only require a single bit or block of bits as the input. The key or control to vary the operation is generally also a block of bits. The full operation can be described with Boolean Logic Operation(s) which are now known by 1st year students. Thus the whole area of encryption and secrecy seems to favour the use of digital rather than analogue signals.

(6) References

1. Denning, Dorothy E.; *Cryptography and Data Security*. Addison-Wesley: U.S.A. (1982).
2. Hellman, Martin E. and Diffie, Whitfield; "Privacy and Authentication: An Introduction To Cryptography". *Proceedings of the IEEE*, volume 67, number 3 (1979).
3. Shannon, Claude E.; *Mathematical Theory of Communications*. University of Illinois Press: U.S.A. (1962).
4. "Data Encryption Standard". *FIPS PUB 46*, National Bureau of Standards, Washington D.C., U.S.A. (1977).

morse trainer

For those who don't know, Morse is a little like binary without the logic. Understandably, learning the Morse code is a long process. In practical use one has to know all the signals by heart, there is no time to even think about it when listening to an actual transmission. Learning them is therefore very much like reciting multiplication tables in school. This is the idea behind the morse trainer.

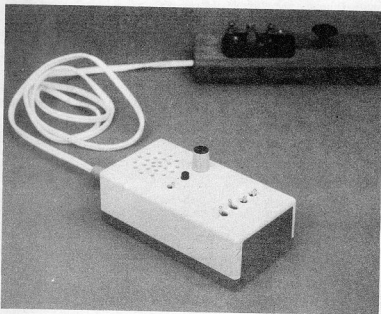

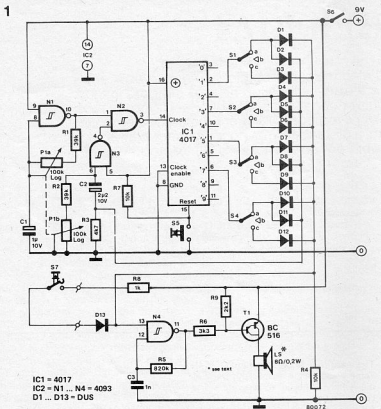

Figure 1. Schematic diagram of the morse trainer.

The morse trainer constantly repeats a certain signal which has been chosen by a few switches. A letter is represented in morse code by a series of dots and dashes, a dash lasting three times as long as a dot. The interval between two dots (and the dashes too) is determined by the clock generator (N1) in figure 1. The clock frequency can be varied for different difficulty factors (DF's?).

When S5 is depressed, the outputs '0', '1', '2', '3', etc. of IC1 (a decade counter) are high in series according to the clock frequency. (The counter switches on the positive slope of the clock squarewave.)

By using the outputs at '1' (pin 2), '3' (pin 7), '5' (pin 1) and '7' (pin 6) only, an equally long logic 0 follows every logic 1 of IC1.

If all the switches S1 ... S4 are on 'c', four short signals are given which enable the low frequency oscillator/amplifier to produce four 'dots' through the loudspeaker. This is the morse code for the letter 'H'. As long as switch S5 is depressed, the decade counter (through the low frequency oscillator) will repeat this signal over and over with short pauses in between.

If a switch is in the 'a' position however, the output of the corresponding pin of IC1 will be connected to an extra diode and an electrolytic capacitor C2. This prevents the clock signal from reaching the counter clock input (pin 14). The capacitor is discharged by R2 and P1b. The setting of P1b determines the time it takes to discharge C2. A dash is the result.

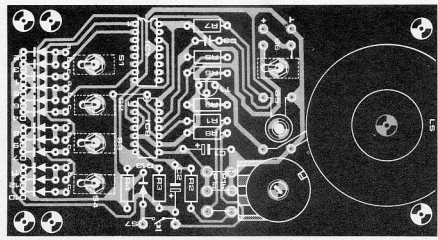

Table 1.

	S1	S2	S3	S4		S1	S2	S3	S4
A	↓	↑	-	-	N	↑	↓	-	-
B	↑	↓	↓	↓	O	↑	↑	↑	-
C	↑	↓	↑	↓	P	↓	↑	↑	↓
D	↑	↓	↓	-	Q	↑	↑	↑	↑
E	↓	-	-	-	R	↓	↓	↓	-
F	↓	↓	↑	↓	S	↓	↑	↓	-
G	↑	↑	↓	-	T	↑	-	-	-
H	↓	↓	↓	↓	U	↓	↓	↑	-
I	↓	↓	-	-	V	↓	↓	↓	↑
J	↓	↑	↑	↑	W	↓	↑	↑	-
K	↑	↓	↑	-	X	↑	↓	↓	↑
L	↓	↑	↓	↓	Y	↑	↓	↓	↑
M	↑	↑	-	-	Z	↑	↑	↓	↓

Table 1. This table shows the positions of the various switches to generate the letters of the alphabet in morse code.

↑ = Switch up

↓ = Switch down

- = Switch half way: no signal

Parts list for figure 2

Resistors:

R1 = R2 = 39 k
 R3 = 4k7
 R4 = R7 = 10 k
 R5 = 820 k
 R6 = 3k3
 R8 = 1 k
 R9 = 2k2
 P1a + P1b = 2x 100 k log.

Capacitors:

C1 = 1 μ/10 V
 C2 = 2μ/2/10 V
 C3 = 1 n

Semiconductors:

IC1 = 4017
 IC2 = 4093
 T1 = BC 516
 D1 D13 = DUS

Miscellaneous:

S1 S4 = Switch SPDT with center off
 S5 = Pushbutton switch N/O single pole
 S6 = Switch SPST
 S7 = Morse key
 LS = speaker, miniature 8 Ω

There are four SPDT switches (S1...S4). Table 1 shows the various positions of the switches in order to generate morse coded letters.

All the morse signals may be created with various combinations of these switches. This excludes figures and other signs.

The printed circuit board is shown in figure 2, along with the parts layout. The four switches can be mounted on the board or at a remote location. If the audio output is too loud for your liking, a 50 Ω pot may be wired in series with the speaker. The output may also be wired to a set of headphones. This will allow for increased concentration, while reducing public irritation!

By connecting a sign key for S7, it is possible to use the trainer for transmission practice. If this feature is used, S5 is not depressed and IC1 is not used at all. By depressing the sign key, the supply voltage will be fed to the low frequency generator. This is accomplished via R8 and D13, causing it to generate a tone through the loudspeaker. **M**

ATTENTION

PCBs & Set of COMPONENTS

for projects are normally available with

precious[®] ELECTRONICS CORPORATION

52-C Proctor Road, Bombay-400 007 Phone: 367459/369478

COMPUTER-CONTROLLED SLIDE FADER (2)

The slide effects unit introduced last month is completed with a control program and an optional keypad that together control no fewer than sixteen slide faders. Although written for the MSX series of home computers, the BASIC program should not be too difficult to rewrite for running on almost any other micro equipped with enough parallel I/O lines for driving the slide controller board(s).

The preparation of a smoothly running slide presentation on four or more projectors is practically impossible without a design tool that enables the photographer to compile his batches of slides, find attractive combinations as regards colour and intensity, and decide on the order, lamp intensity and the time a particular slide is shown. Once all this has been decided on, revised, and once more verified in a trial run of the show, it is possible to store all the necessary commands in the computer for retrieval and automatic execution at a later stage. To aid and guide the many enthusiastic photographers keen on showing their achievement to a larger audience, we have written a BASIC programme for MSX computers, and developed a special command keypad that connects to the computer's joystick input.

Overview of functions

A short description of the commands supported by the slide controller program is given in the Table below. Clearly, the success of the visual effects draws on the photographic ingenuity of the operator, *in casu*, the programmer

who creates the file that contains the commands to be executed sequentially. The artistic aspects of creating a slide presentation are not dealt with in this article; general considerations and useful hints can be found in books and magazines on the subject of photography.

When the program is started, it displays the menu screen (see Fig. 1). The user is prompted to select automatic or manual operation by the flashing text:

```
[A]UTO  
[M]ANUAL
```

The capital letters in square brackets denote the key to be pressed for the associated function. Typing M makes it possible to use the keyboard for selecting control commands from a menu. The selected function is marked with an asterisk (*). The largest possible array of slide projectors is composed of four blocks of four projectors, each with its own address area in the I/O and Timer Cartridge for MSX micros. This arrangement is equivalent to four I/O cartridges fitted in parallel in a single I/O

slot, and enables controlling 16 projectors simultaneously via 4 slide controller boards (keep an eye on the total current consumption). Keys [shift]1...[shift]4 select the block number, and keys 1...4 the individual projector. Provision has been made for the simultaneous selection of multiple projectors, which need not be part of the same block. After selecting the projector(s), the command(s) can be issued. Options are displayed at the top of the menu.

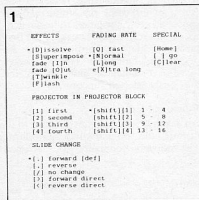

Fig. 1. The start-up menu prompts the user to enter functions and control commands for the slide fader unit(s).

SUMMARY OF EFFECTS ON COMPUTER-CONTROLLED SLIDE FADER

Fade types:

hard; snap; cut; flip
fast to very slow

very fast fading (<1 s).
1... >10 s.

Double projection:

superimpose
flash

projects two slides simultaneously.
flash-like appearance of a slide onto the projected image.

partial image

a number of masked slides are projected simultaneously.

Twinkling and animation Fade in

fast sequential projection of slides.
projector lamp intensity is gradually increased.

Fade out
Clear

projector lamp intensity is gradually reduced.
all slide carriages are returned to position 1.
forward, reverse.

Slide carriage control

To begin with, there is, of course, the slide fade effect. This is obtained with the aid of command "dissolve". The lamps in all projectors that illuminate the reflective screen are quenched, and those in the selected projectors are gradually turned on. Function "superimpose" is similar to "dissolve", but works with half the light intensity. Function "fade in" turns the lamp in a particular projector on at a certain speed, without quenching the lamps in the other projectors. "Fade out" is the complementary function. The fading rate for the above functions is programmable: fast; normal (5 s), long (15 s) or extra long (30 s).

The "twinkle" effect gives a fast, sequential projection of slides in a number of projectors (running-light effect),

while "flash" gives a brief, single, projection of one or more slides.

Five options are available for slide carriage control. The first, "forward", is the default function that results in automatic feed-forward of the slide carriage following a fade-out command, i.e., it can only operate in conjunction with effects "dissolve", "superimpose", and "fade out". Function "reverse" is similar to "forward", except, of course, for the direction of travel of the slide carriage. Automatic slide changing is disabled with function "no change". Functions "forward direct" and "reverse direct" give instantaneous slide changing. Selected projectors provide a fade out (unless the lamp was already quenched), followed by a slide carriage feed in the relevant direction.

As to the special functions shown in the menu: "go" (space bar or return key) runs the selected function or effect. The selected function is not carried out, however, before the relevant projectors have completed previously received commands. Function "home" has two options. Pressing the home key causes the selected projector(s) to revert to the first slide, but not before the projector(s) lamp(s) is/are quenched. Pressing the [shift] and [home] key simultaneously causes all projector lamps to be quenched, all slide carriages to be set to the first position, and all projectors to be deselected. Function "clear" ignores keyed-in commands, and restores the previously selected function.

Command strings

An example may help at this stage to illustrate the programming procedure. The following command string is keyed in:

[shift]4IQ12 F3 4 ON1234[return]

Note that the 3 spaces are significant, as they stand for "go". [shift]4 selects projector block 4 (projector numbers 13...16 incl.). I and Q announce a fast fade-in on projectors 1 and 2 of block 4 (numbers 13 and 14). The space character that follows causes the programmed function to be carried out. F3 selects a flash on projector 3 in block 4 (number 15), and the space brings it into effect. 4[space] causes a flash on projector 16. Note that it was not necessary at this stage to type another F, since the flash function is still in operation. The next command sequence, ON1234[return] results in a fade-out at normal speed, followed by a carriage feed-forward. The fade-out is not effected on projectors 15 and 16, since these had their lamps fully quenched already, but the automatic feed-forward (default) is still effected. Commands and selections are not brought into effect before "go" is selected; editing of command sequences is, therefore, possible. Selection of other projectors is, however, only possible after a "clear" command.

Automatic control

It is, of course, convenient to run the compiled presentation automatically. The control program supports automatic operation with or without tape synchronization.

Projector commands can be put in DATA lines from line 8000 onwards (an example of an automatic presentation is included in the programme listing). The structure of the lines is similar to the previously discussed strings that are entered manually. If available, the disk drive on the computer may be used for storing projector commands on floppy disk. Disk or tape storage is not supported by the control program, however,

so that suitable save and load procedures will have to be provided by the programmer.

A number of additional program functions are available during the automatic execution of the slide show. Pressing key "M" reselects manual operation, while "A" reverts to the automatic mode, in which the computer continues processing the data from where it was interrupted. If necessary, slide carriages are returned to the positions they had before the automatic mode was interrupted. Function "W" waits for the space bar to be pressed, or for "M" to select manual operation. This makes a short pause possible for exchanging complete slide carriages. Function "R" (restore) causes the program to start at the first data line, after returning all projectors to the initial settings. Function "E", finally, ends the show. Programmers should note that "E" and "R", contrary to the other functions, must each be put in a separate data line. The home key can not be put in a data line in the form of an ASCII character. This problem has been solved by the use of letters "h" and "H", which represent [home] and [shift]home, respectively. The other functions recognize both capitals and lower case letters.

Synchronization to a tape recording is effected via the trigger input on the joystick interface (hardware), and the wait-for-tape routine (software). The (relay) output of the pulse decoder is connected between trigger input A and GROUND of joystick I. A simple record/playback system for taperecorders is shown in Fig. 2. The 1 kHz tone generator (Fig. 2a) is activated by pressing S1. The tone decoder (Fig. 2b) is connected to the AF output of the recorder, and energizes the relay contact when the tone is detected as the tape is being played back.

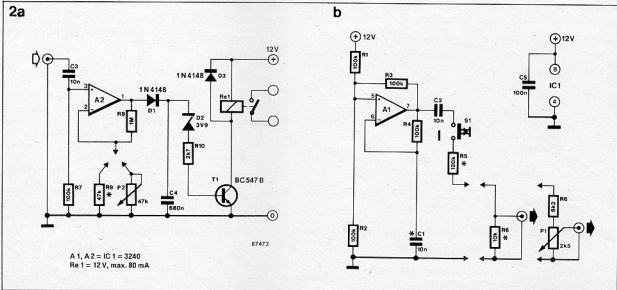

Fig. 2. Circuit diagram of a simple tone generator (2a) and associated decoder (2b) for tape synchronization.

The Record-Playback Amplifier described in (1) is ideal for use in conjunction with the tone generator and decoder. To prevent it being overdriven by the tone generator, it is recommended to use the resistor-potentiometer configuration shown as an option for the circuit of Fig. 2a. Also, C_1 is best increased to 100nF to lower the tone frequency to about 100 Hz. In the tone decoder, P_2 is fitted instead of R_0 to enable accurately setting the optimum sensitivity.

Programming the slide sequence is facilitated by the message "press button", displayed following the execution of a command. The user can then arrange for the next synchronization pulse to be recorded on tape.

Program description

The program listing starts with an overview of the variables used (lines 140...530). This should prove helpful for possible extensions at a later stage, and prevents the programmer losing track of declared variables. Many variables are declared as arrays, in which each element belongs to a particular projector. There are also arrays that contain only two elements. These are not declared beforehand, since this is not required in MSX BASIC for arrays of up to 11 elements (0...10 incl.). A number of variables will be discussed below with an aim to clarify the operation of the control program, and to aid programmers of non-MSX computers converting the software for use on their machine.

Variable X is a counter used within the ON INTERVAL routine in lines 5500...5690. This variable may not be used for other purposes after the ON INTERVAL initialization, because intervals always return X as 16, irrespective of the previously assigned value. Arrays T1...T6 hold the timing periods that are used during the changing of the slides. T1(I) determines the on-time of the feed-forward relay that controls the carriage in projector 1. T2(I) indicates the wait time before the change is complete. T(3)I and T(4)I have similar functions for reverse changing. Variables T(5)I and T(6)I serve as counters during the changing period. Their starting value is copied from T(1)I and T(2)I, or T(3)I and T(4)I. The values in arrays T1...T4 depend on the specifications of the projectors used, and may be defined individually for each projector. In practice, it will be found that a single value for the arrays enables satisfactory operation of all projectors, even if these differ in respect of type and make.

Arrays B1 and B2 indicate activity of any one projector in the system. B(1)I indicates whether or not the lamp intensity for the relevant projector is being changed, while B(2)I signals slide chang-

ing activity. The fade rate is set by the values in S(1), S(2), DE(1) and DE(2). S(1) and S(2) indicate the step size used for increasing or reducing the lamp intensity. DE(1) and DE(2) define the number of times the ON INTERVAL routine is skipped before the lamp intensity is re-adjusted. The values assigned to these variables depend on the selected FADING RATE. The (temporary) step size and delay information are recorded separately for each projector with the aid of variables SI(1), D(1)I and D(2)I. Among the most essential lines in the program is number 860. This determines the rate at which the command execution subroutine is called. Statement ON INTERVAL=15 causes the main program that arranges the entering of commands to be interrupted at $15 \times 20 = 300$ ms intervals to write new data to the slide controller board(s). Command input is thus separated from command output, preventing key actions

disrupting an effect while this is being executed. The interval rate is set to 300 ms to allow sufficient time for the computer to run the interval routine (line 5500...5690). Too short an interval time would cause the interrupt to be generated during the execution of the interval routine, making it impossible for the computer to return to the main program. It was found that 300 ms gives a reasonable time division between the main program and the interval routine. If the interval time is changed, all variables containing period definitions must be changed also (T1...T4, DE1, DE2, S1 and S2).

An optional keypad

The circuit diagram of an external, optional, keypad for entering all program functions is given in Fig. 3. The keypad is connected to the second joystick input, and is essentially an extended ver-

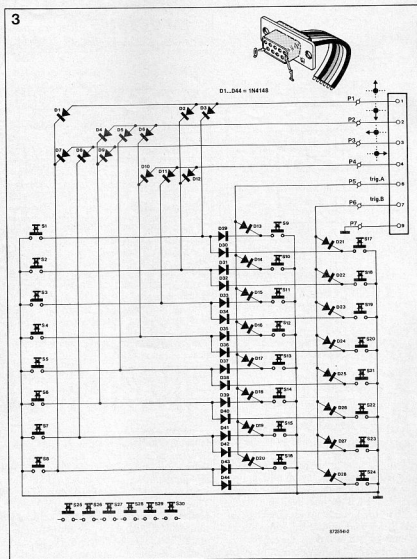

Fig. 3. Circuit diagram of the auxiliary, optional, keypad connected to the joystick input on the computer.

ATTENTION

PCBs & Set of COMPONENTS

for projects are normally available with

precious®
ELECTRONICS CORPORATION

52-C Proctor Road, Bombay-400 007. Phones: 367459/369478

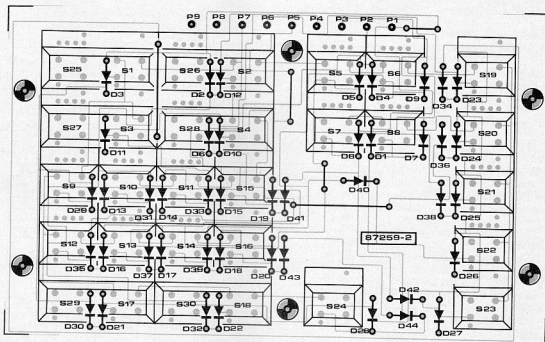

Fig. 4. Layout of the keypad PCB (not available through the Readers Services).

sion of the circuit described in ⁽²⁾. Figure 4 shows the track layout and component mounting plan. It should be noted that this PCB is **not** available ready-made through the Readers Services. Buttons S₂₅...S₃₀ incl. are dummy switches covered by 6 double-size keytops.

The machine-language routine that belongs to this control keypad is linked to the computer-resident keyboard driver (lines 5800...5990). When writing or

debugging one's own control routines, it is important to remember that the keyboard routine is loaded only once. This is so arranged because the hook vector that points to the keyboard routine of the computer is moved and replaced by the start address of the keypad routine. Running this procedure twice causes the computer to lose track of the starting address of the resident keyboard driver, so that the slide control program

Parts list

- 9-way female sub-D connector
- D1...D44 incl. = 1N4148
- S1...S30 incl. = PCB mounted data switch; momentary action. Licon series 61 Alpha Type 61-101xx00 (xx is keycap colour code).
- Keycaps: 6 off double, and 18 off single. ITW
- Switches • Division of ITW Limited •
- Norway Road • Hilsa Industrial Estate •
- Portsmouth PO3 5HT. Telephone: (0705) 694971. Telex: 86374.

is apparently not working. Data errors reported during tests invariably require instruction POKE &HF975,00 to be run before restarting can take place.

The keypad routine can be tested separately with the aid of line

KEY = STICK(X) - (8 * STRIG(X)) - (16 * STRIG(X + 2))

where X is the number of the joystick port.

Alternatively, use

```
1 DEFINT A: A =USR0(0): IF A<>0
  THEN PRINT A: GOTO 1 ELSE 1
```

Instruction A=USR0(0) fetches the number of the actuated key. Its effect is similar to statement AS=INKEYS. The routine has a buffer with a holding capacity of 128 key actions. The buffer is

cleared by pressing keys [shift] and [clear] sequentially, while just [clear] empties the buffer until the last "go" command. The [shift] key must always be pressed individually to ensure that the keypad routine assigns a different number to the next key pressed. The key numbers returned by the routine correspond to the numbers of the switches (1...23 incl.; 24 is the [shift] key). The number is increased by 24 when the previously pressed key was [shift] (25...47 incl.). The keypad routine returns a nought to indicate that no key was pressed when it was called. R

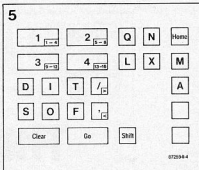

Fig. 5. Location and lettering of the keys on the auxiliary keypad.

References:

- (1) 16-key input for MSX micros. *Elektron India*, September 1987.

Frequency doubler using 4011

This frequency doubler uses one CMOS quad, two-input NAND gate package type 4011. The frequency doubler proper consists of an inverter N1, two differentiating networks R1/C1, R2/C2 and NAND gate N3. N1 and N4 function as input and output buffers.

The incoming signal is buffered and inverted by N1, giving waveform (A) (it is assumed the waveform has 1:1 mark-space ratio). (A) is inverted by N2, giving waveform B, which is the complement of (A) (i.e. it is in antiphase). The negative-going edges of waveform (B) are differentiated by R2 and C2, giving waveform (C), while (A) is differentiated by R1 and C1, giving waveform (D). Waveforms (C) and (D) are fed into N3, and every time one of these waveforms is negative-going a positive-going pulse appears on the

output of N3, (waveform E). The output of N4 is an inverted version of (E). The switching threshold of CMOS logic is about 45% of supply voltage, so the switching point of N3 on the rising exponential portions of waveforms (C) and (D) will occur at this point. The time taken for the waveform to rise to this voltage is just less than the time constant RC, so the pulse duration of waveform (E) is approximately equal to the time constants R1C1 and R2C2. For reliable operation these time constants should be chosen to be much less than the shortest possible period of the input waveform. The reason for this is that the width of the positive-going pulses (E) is constant, but the length of the spaces between them diminishes as the input frequency increases. If the pulses are not of short enough duration they may overlap at high input frequencies.

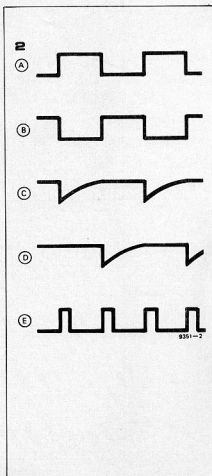
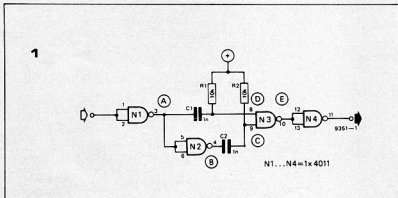

PLOTTER (part 1)

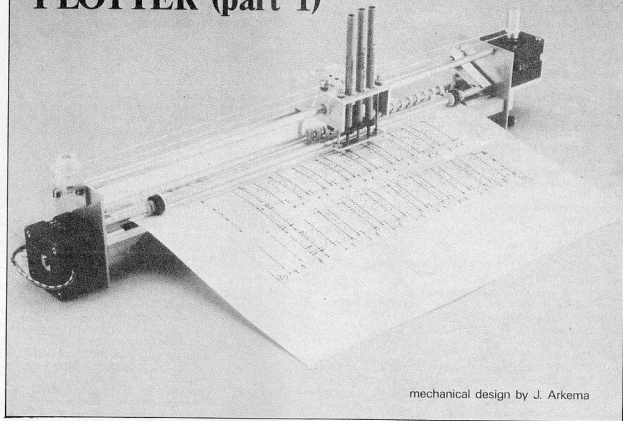

mechanical design by J. Arkema

Many owners of a personal computer and associated peripheral equipment will at some time have wished that graphics information available on screen could be sent to a plotter instead of a slow, noisy printer operated in the dot-matrix mode. But then, even the simplest of plotters is often more expensive than the computer itself.

Not so the plotter described here, which is a unique project: fairly simple to build, complete with a versatile and power-efficient stepper motor interface driver, available in kit form, and offering a good price/performance ratio. The final accuracy of the plotter should be adequate for a host of graphics applications, and depends mainly on the constructor's mechanical skills.

Matrix printers are fine for text applications, but can not handle graphics information very well. They are invariably slow because in the bit image mode pixels are printed one line at a time. In addition, their resolution is insufficient for many applications, they are noisy, and only very few types can handle large sheets of paper (A2; A3).

The plotter described here is not of the X-Y type commonly found in the least expensive class of commercially available plotters, but is similar to a standard text printer in that it has a pen carriage for the horizontal (X) direction, and a platen (paper roller) for the vertical (Y) direction. This approach makes

it possible to keep the mechanical construction relatively simple, while allowing many paper sizes to be used. The platen is driven direct by a stepper motor; the pen carriage indirect by a string and a second stepper motor.

Arguably, in the absence of an absolute X-Y reference point, this arrangement has the disadvantage of being subject to accumulative positioning errors. Fortunately, deviations caused by these errors can be kept small in practice by ensuring that the paper and the carriage are not obstructed in their respective movement.

Small electro-magnets are used for lifting and lowering the three pens. These are simply refills available from

bookshops and warehouses, and come in various colours for many types of inexpensive drawing pen. The pen carriage on the plotter is shown in the photograph of Fig. 1.

The stepper motor interface board for the plotter can be driven by an 8-bit Centronics port, which is a standard outlet available on the majority of modern computers. Control bits are arranged in a manner to enable direct connection of the Centronics port to the plotter interface board via a length of flat ribbon cable. The control circuit has been designed for efficient powering of the stepper motors and pen magnets. The power supply, exclusive of the mains trans-

former, is accommodated on the interface board to make for a compact and simple to connect unit.

Mechanical construction

The plotter is essentially a beam construction as shown in Figs. 2a and 2b. Two aluminium support plates (60×70×2 mm) at either side hold the complete assembly in between them. The stepper motors are secured to the outside of the plates. Three round bars (dia. 6 mm solid aluminium or stainless steel tubing), and one square bar (10×10 mm aluminium) are fitted between the support plates. The length of the bars determines the maximum paper size, and can be dimensioned to individual requirement. A length of 508 mm, for example, enables sideways drawing on A2 size sheets of paper, often used in the graphics industry.

Details on the construction of all the mechanical parts for building the plotter are shown in the working sheet of Fig. 3. The paper roller is a round aluminium rod (spindle) of 12 mm diameter fitted immediately behind the square bar. Good grip on the paper sheet is ensured by reducing the diameter of the platen a few tenths of a millimeter over two lengths of 30 mm by turning in a lathe, and covering these areas in very fine sandpaper, wound spirally and glued

onto the aluminium surface. Every precaution should be taken to prevent the total diameter of the platen increasing where the sandpaper is secured. Two pressure rollers, fitted on a movable axle, rest on the sandpaper grips (see Fig. 4). To insert or remove a sheet of paper, the axle can be lifted by means of two small tilt levers made from aluminium U-beam. The rollers are firmly pressed onto the paper by the pull of two small springs.

The platen is driven direct by a stepper motor with a step size of 200 per revolution. At the indicated platen diameter of 12 mm, this results in a resolution of 0.19 mm/step. Half-step operation is also supported by the driver board, increasing the attainable resolution to slightly less than 0.1 mm.

The pen carriage is in essence a short length of aluminium U-beam. The guide rod runs through nylon slide bearings (Skiffy) secured in holes drilled in the legs of the U. Tilting of the pen carriage is prevented by its rear side resting on another rod. Carriage movement on the guide bar is effected with the aid of a string. This is wound one and a half turn around a shaft, up to the height of the securing screw, and then a further six to ten turns upwards. The shaft is made from the same material as the platen, and is fitted onto the spindle of the stepper motor. For optimum accuracy, the total diameter of the shaft plus string should equal that of the platen (12 mm).

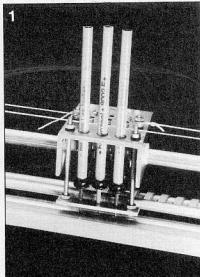

Fig. 1. The movable carriage on the plotter holds three pen refills in different colours. Not visible in the photograph are the associated electromagnets for pen up/down control.

This ensures equal pen travel per step in the X and Y direction. Each pen is guided through a hole drilled in the top of the U-beam, while the tips are kept firmly positioned on or above the paper with the aid of a support plate. The square aluminium bar in front of the

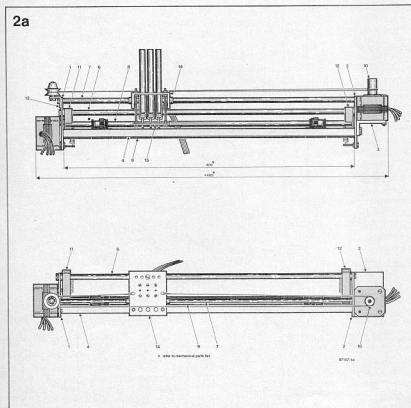
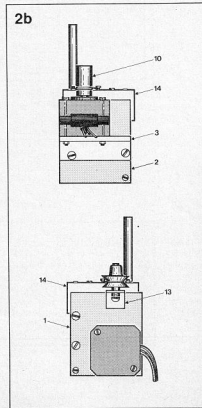

Fig. 2. Working drawings of the assembled plotter seen from the front and top (a) and from the sides (b).



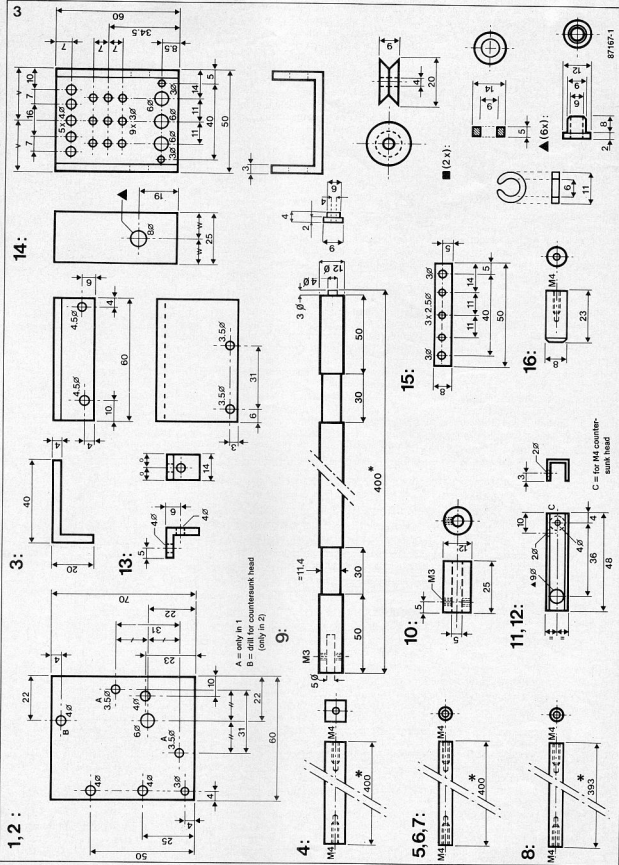

Fig. 3. Dimensions of all nylon and aluminium or stainless steel parts that must be cut, filed, turned and drilled.

Mechanical Parts list

1. side plate; left; aluminium; 60 × 70 × 2 mm.
2. side plate; right; aluminium; 60 × 70 × 2 mm.
3. angled support bracket for X motor; L-shaped aluminium; 20 × 40 × 4 mm; length 60 mm.
4. square connection bar; aluminium 10 × 10 mm; 400 mm long*.
5. round connection bar; aluminium/stainless steel rod; dia. 6 mm; 400 mm long*.
6. round support bar for pen carriage; dimensions as 5l.
7. round guide bar for pen carriage; dimensions as 5l.
8. round bar for pressure rolls; aluminium/stainless steel rod; dia. 6 mm; length 393 mm*.
9. platen; round aluminium bar; dia. 12 mm; length 400 mm*.
10. shaft; aluminium; dia. 11.2 mm (see text); length 25 mm.
11. tilt lever for pressure rolls spindle; U-shaped aluminium beam 10 × 10 × 1 mm; length 48 mm.
12. see 11).
13. angled support bracket for string wheel; U-shaped aluminium beam 15 × 15 × 2 mm; length 15 mm.
14. pen carriage; U-shaped aluminium beam 25 × 50 × 3 mm; length 60 mm.
15. pen positioning plate; aluminium; 8 × 50 × 2 mm.
16. pen carriage support; nylon; dia. 8 mm; length 23 mm.

Miscellaneous parts:

- 6 off slide bearings; nylon; Skiffy 08-6.
- 1 off bushing for platen; nylon; Skiffy 08-4 or 08-6.
- 2 off washer rings; internal dia. 3 mm; thickness 2 mm.
- 2 off rubber pressure rolls (e.g. cable grommet).

- 4 off fixing rings for dia. 6 mm spindle (e.g. Skiffy 11-1-6).
- 1 off string wheel.
- 3 off cylinder head screws M4 × 5.
- 2 off cylinder head screws M4 × 10 (for fixing part no. 3).
- 1 off cylinder head screw M4 × 20 with 3 nuts.
- 5 off M4 × 5 screws with countersunk head.
- 4 off cylinder head screws M3 × 40 (for fixing stepper motors).
- 2 off cylinder head screws M3 × 50 (for fixing part no. 15).
- 2 off cylinder head screws M3 × 10 (for fixing string).
- 2 off cylinder head screws M3 × 15 (for fixing spring brackets).
- 4 off headless adjustment screws M3 × 3 (for fixing part nos. 9 and 10).
- 6 off bolts M2.6 × 5 (for fixing pen lift magnets).
- 16 off hexagonal nuts M3.
- 2 off springs for pressure rolls spindle.
- string; wound fishing line; 1100 mm*.
- fine grade sandpaper (for securing on platen).

Electromechanical parts:

- 2 off stepper motors; 200 steps/rev.; dual-phase bipolar; 200 mA/phase (e.g. Berger as used in disk drives).
- 3 off pen lift electromagnets; 12 V; e.g. Binder Magnete Type 40031-09800.

* Length in accordance with required size of plotter.

Distributor of Skiffy products in the UK is
Salterfix Fasteners • Salter Springs & Pressings Limited • Spring
Road • Smethwick • Warley • West Midlands B66 1PF. Telephone:
(021 553) 2929. Telex: 337877.

platen functions as a flat surface onto which the paper rests as the lines are drawn on it. An electromagnet to each pen arrangement for this to be lifted from the paper when its colour is not required at a particular co-ordinate position on the sheet.

The drawings and photographs in this article, in combination with the mechanical parts list, should give sufficient details on the basic construction of the plotter, which is reverted to below.

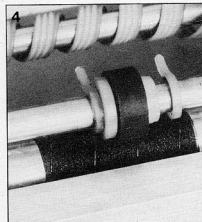

Fig. 4. Close-up of the sandpaper grip on the platen, and the associated pressure roller plus clips on the movable axle. Also note how the 4-way flatcable to the carriage is wound on the rear rod to make a flexible connection with the plotter interface board.

Circuit description of the plotter interface board

The control circuit developed for the plotter is composed of a power supply, two stepper motor drivers, three buffers for energizing the pen lift solenoids, and an 8-bit digital interface to the Centronics standard.

The diagram of Fig. 5 shows that the circuit is based around integrated stepper motor drivers Type MC3479 from Motorola or SGS. Three inputs of each chip, clock, full/half step and direction, are driven direct by the computer via the input connector. The fourth input, OIC, enables selection between high or low impedance termination of the energized stator winding during half step operation. This selection is used for optimizing the dynamic response of the relevant motor. The resistor connected to the SET input of the driver IC determines the stator current. In the non-activated condition, T₄ and T₅ are turned off, so that the resistance between the SET inputs and ground is relatively high. This effectively keeps the stator current between 60 and 70 mA, ensuring a modest total dissipation of the motors and the driver ICs, whilst maintaining sufficient torque to keep pens and paper securely in position. A stepper motor is energized when the interface board receives a positive pulse transition on the relevant clock input (cl₁/2). The associated MMV is triggered, switches on the transistor (T₄ or T₅), and causes the stator

current in the motor to rise to about 200 mA per phase. This rush-in current flows only briefly due to the inductance of the stator, and depends on the step rate. The driver IC, however, will counteract this reduction—within the practical limits of the supply voltage—to force a current flow of about 200 mA.

Opening switch S₂ disables the stepper motors to allow manual positioning of the carriage and/or the paper on the platen. In addition, opening S₂ resets the logic circuitry internal to the driver ICs to the initial state, as indicated by the illuminated LEDs. This state occurs at each fourth (or eighth) step, and the LEDs will light correspondingly.

The circuit for controlling the pen lift solenoids is relatively simple. Two-to-four decoder IC₃ selects one of the three pens. When both IC inputs are held logic high, or are not connected, all three pens are lifted. The electromagnets are actuated via darlington transistors and R-C networks. In these, the capacitor ensures a relatively high pull-in current, while the resistor limits the hold current to a level that is just high enough to keep the electromagnet actuated. Flyback diodes are fitted across the coils to suppress induced voltage peaks.

Cutting, drilling, filing...

The mechanical parts are made or purchased as indicated in the Mechanical Parts List and the working sheet of

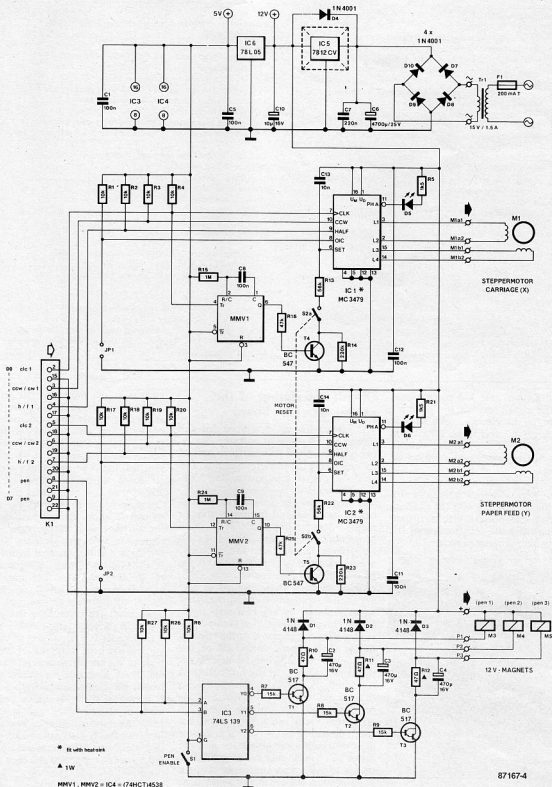

Fig. 5. Circuit diagram of the plotter interface board.

Fig. 3. Each of the 16 parts that must be made to size is shown separately and with the relevant dimensions. The side panels are cut from a 2 mm thick sheet of aluminium. They are preferably clamped together and drilled simultaneously to ensure accuracy. Use a centre punch for precise positioning of the drill, and lubricate this every now and then with methylated spirit to avoid burrs, and to clear aluminium shavings. A countersink drill should be used for sizing the upper hole in the right-hand support plate, which receives the head of the countersunk M4 screw bolt. The head must not protrude from the plate surface because this lies flat against the side of the stepper motor. Two additional 3 mm holes are drilled in the left-hand plate for securing the Y motor. Rods 4, 5, 6 and 7 are cut to equal size as required for the width of the platter. The centre of both ends of each rod is pre-drilled with a 3.3 mm drill before tapping an M4 thread. Be sure to drill exactly in the centre of the axle: a lathe is, of course, ideal for this operation, but not strictly required for acceptable accuracy.

There is, however, no way to go round the use of a lathe for reducing the platen diameter where the sandpaper is to be secured. Unfortunately, a lathe is neither easy to control nor a commonly available tool. It is, therefore, recommended to have the platen turned to the required local thickness in a mechanic's workshop. Also remember that drilling an off-centred hole in the platen where it is secured to the motor shaft will wreak havoc by causing friction in the nylon bushing at the other end of the rod, and, more seriously, irregular paper motion. The free end of

the platen is turned to a diameter of 4.2 mm over 4 mm with the aid of a lathe to enable it to revolve in the nylon bushing. The shaft fitted onto the spindle of the second stepper motor is made by cutting off a short length of the platen tubing. The remaining components, 11...16 incl., are relatively simple to make and require no further discussion.

Construction of the interface

The plotter interface board is a single-sided type which is available ready-made through the Readers Services. Construction is straight-forward by reference to the parts list and the component overlay of Fig. 8. Resistors R_{10} , R_{11} and R_{12} are 1 W types mounted slightly off the board surface to aid in their cooling. Drivers IC_1 and IC_2 require fitting with a DIL clip-on or glue-on heat-sink—see Fig. 6. It is recommended to solder the IC s direct onto the board, so that the ground area can aid in convecting dissipated heat. IC_1 is a type from the 4000 series, and has the disadvantage that its input is not TTL-compatible. In practice, however, pull-up resistors R_1 and R_{20} ensure correct operation of the interface in conjunction with virtually any Centronics port. None the less, when incompatibility problems are suspected (the motors then appear not to start properly), IC_1 may be replaced by an equivalent of the HCT type. Jumpers JP_1 and JP_2 are not fitted.

As already stated, the input header on the board is wired in a manner that facilitates connection to a Centronics port via a length of flat ribbon cable. Handshaking is not used in this arrangement.

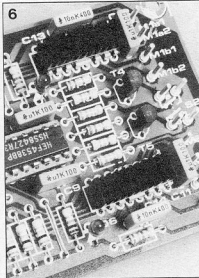

Fig. 6. The stepper motor driver ICs on the interface board require cooling by heat-sinks of a type that can be glued on top of a DIL package.

A note on stepper motors

The stepper motors used for building prototypes of the plotter were Berger types salvaged from discarded disk drives. Similar types may be used if these have the following specifications:

- 200 or 100 steps/rev. ($\approx 1.8^\circ$ or 3.6° per step);
- current consumption: approx. 200 mA/phase;
- two bipolar phases;
- resistance for each phase (stator): 30...40 Ω .

Unfortunately, many motors may not meet with the above specification in respect of the stator resistance. These types exhibit much lower values (e.g. 1.33 Ω), and require driving from current sources. According to the manufacturers, the driver ICs Type MC3479 on the plotter interface board have current source output stages, but in practice these may be damaged when connected direct to a very low stator resistance. It is, therefore, good practice to check the stator resistance of the motors envisaged for use in the plotter. If necessary, add a suitably dimensioned series resistor to ensure that each stator output on the driver ICs is loaded with 30...40 Ω . Example: use a 33 Ω ; 4 W resistor when the stator alone has a resistance of 1.33 Ω .

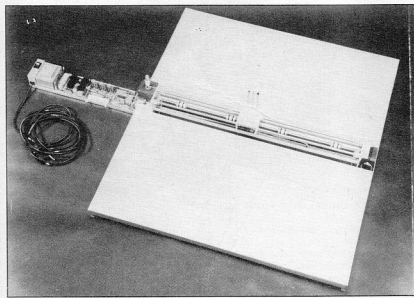

Completed prototype of the plotter. This is a relatively wide version (508 mm) mounted on a flat aluminium base plate for improved paper stability (A2 sideways; A3 lengthwise). It has four paper grips to ensure that lines of minimum thickness are drawn reliably and accurately.

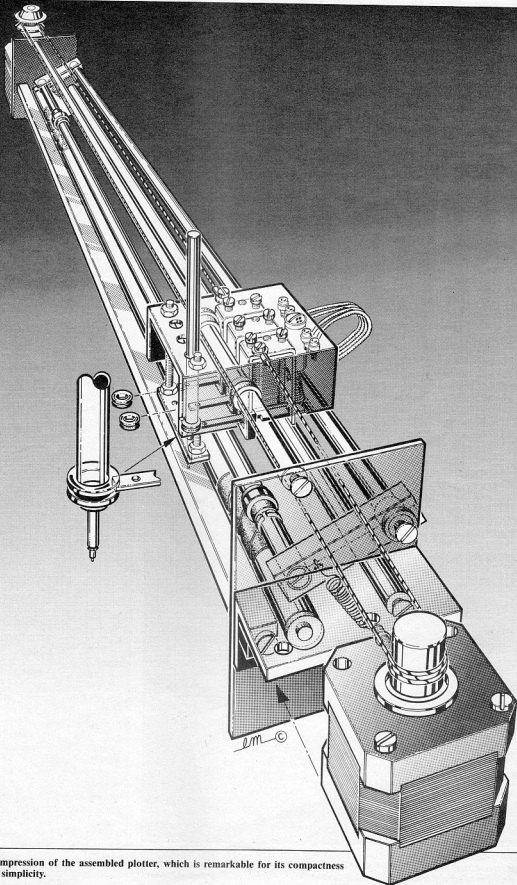

Fig. 7. Artist's impression of the assembled plotter, which is remarkable for its compactness and mechanical simplicity.

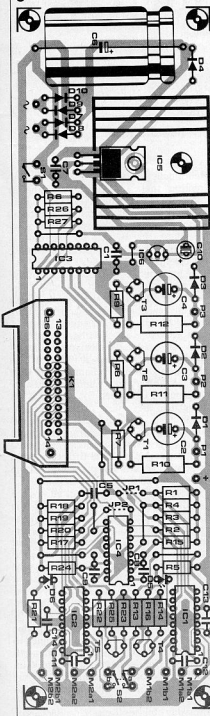

Fig. 8. Track layout and component mounting plan for the plotter interface PCB.

The completed board is secured onto the mains transformer and the plotter. The two switches are connected as external controls, together with the mains switch. Do not forget the mains fuse, which should be connected ahead of a suitably rated DPDT mains switch. A Euro-style mains entrance socket with integral switch and fuseholder is, of course, the

ATTENTION

PCBs
& Set of **COMPONENTS**

for projects are normally available with

precious® ELECTRONICS CORPORATION
52-C Proctor Road, Bombay-400 007 Phones: 367459/369478

safest and easiest alternative in this respect. Indicators D_5 and D_6 need not be visible when the interface is fitted in an enclosure, although this may prove useful during testing and setting up.

Part 2 of this article will deal with general considerations on control software for the plotter.

Parts list

STEPPER MOTOR INTERFACE BOARD

Resistors ($\pm 5\%$):

R1...R4 incl.; R6; R17...R20
incl.; R26; R27 = 10K
R5; R21 = 1K5
R7; R8; R9 = 15K
R10; R11; R12 = 47R; 1 W
R13; R22 = 56K
R14; R23 = 220K
R15; R24 = 1M0
R16; R25 = 47K

Capacitors:

C1; C5; C8; C9; C11; C12 = 100n
C2; C3; C4 = 470 μ ; 16 V; radial
C6 = 4700 μ ; 25 V
C7 = 220n
C10 = 10 μ ; 16 V
C13; C14 = 10n

Semiconductors:

D1; D2; D3 = 1N4148
D4; D7...D10 incl. = 1N4001
D5; D6 = red LED
T1; T2; T3 = BC517
T4; T5 = BC547
IC1; IC2 = MC3479 (Motorola; SGS) (C-1 Electronics)
IC3 = 74LS139
IC4 = 4538 or 74HCT4538
IC5 = 7812
IC6 = 78L05

Miscellaneous:

S1 = miniature SPST switch.
S2 = miniature DPDT switch.
K1 = 26-way right-angled IDC header for PCB edge mounting.
Mains transformer; 15 V/1.5 A secondary.
Euro-style mains entrance socket with integral fuseholder and switch.
Fuse; 200 mA delayed action.
Heat-sink for ICs.
DIL heat-sinks for IC1; IC2.

ARTIFICIAL INTELLIGENCE

by M. Seymour, BSc, University of St. Andrews

Man is intelligent, but his intelligence is often thwarted (or worse) by his environment. That realization has given rise to a dream: that one day it may be possible to build a machine that can think, that is, need not be programmed to perform its functions.

Machine intelligence was first thought of by Charles Babbage (1792-1871). This century, Alan Mathison Turing (1912-1954) has achieved immortality through the Turing Machine, which purports to show that machines are mathematical objects, and his proof of the theorem that the set of mathematical tasks that is computable is exactly the same as the set that can be executed by the machine. He also formulated a theory about what questions could in principle be answered by an intelligent machine.

Artificial intelligence grew out of the work on digital computers during the Second World War and was officially recognized as a branch of computing science in 1956. Since those early days, artificial intelligence has given rise to a number of myths, particularly, but not only, in the popular press. However, claims of computers achieving this and that, without human intervention, always prove, on close examination, to be mere illusions of intelligence. These illusions are created by the fact that computers work so extremely fast.

Fortunately, such illusions are now recognized as such and the true science of Artificial Intelligence is taking shape. The aim of this science is not to create machines that are as intelligent as humans (it is doubtful whether this will ever be possible), but rather to create machines that are ever more capable of meeting human needs. Such machines need to be able to learn about their users and to do that, they will have to see, hear, and understand. Moreover, they must not make demands on their users as far as programming is concerned. Ideally, this would mean that the machine responds to normal spoken language. Only limited progress has been made in that direction.

The theory of artificial intelligence says that if you analyse the world in symbols and put the right rules (=program) in the machine it will have a mind and understand the world as we do. In other words, it will be a thinking machine. Some researchers say that any computer can simulate any other computer, be it serial, parallel, digital, or analogue. Assuming the human brain to be a computer, they assert that it must be possible to find the program that makes the

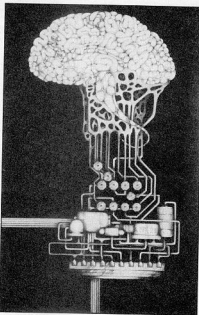

human computer function. Once found, this program can then be used to run any other computer, which will consequently be intelligent. But is there such a program and will it ever be found?

Other researchers feel that because of the world we live in, we suffer from the illusion that every substantive problem should have a technological or scientific solution. Because such answers are not forthcoming, we believe that a better technology or a more advanced science is required to solve the problems. It is easy to think of artificial intelligence in this context.

These researchers do not believe that it is simply a matter of calling our brain a computer and saying that it has been 'programmed'. Human intelligence is not just the ability to think logically: there is memory, experience, background, emotion, and so on. It is, perhaps, experience that creates the greatest distinction between artificial and natural intelligence. The relationship between human mental events and experience of the real world is called in-

tionality. It is these researchers' contention that no existing machine or program has intentionality. Artificial intelligence is, at present, proceeding along the lines laid down by these researchers, that is, with the aim of constructing a machine that is most capable of meeting human needs.

The most publicly visible applications so far are so-called Expert Systems. These are programs that are used to give advice on medical diagnosis and prescription, genetic engineering, chemical analysis, and geological prospecting for minerals and oils. Although most of these programs are very limited in what they can do, some give more reliable advice than all but the very best human experts.

Computers developed for Artificial Intelligence are called fifth generation computers. The first four generations are defined in hardware terms: machines based on valves; transistors; integrated circuits, and VLSI. The fifth generation is defined in terms of parallel operating hardware and artificial intelligence.

Although the governments of all western nations, and, no doubt, that of the USSR also, are pouring money into the research and development of fifth generation computers, workers, in the field have found that the difficulties involved have been grossly underestimated. One of the important facts that has emerged is that human common sense plays a far greater role in our daily lives than hitherto generally imagined.

Common sense enables people to cope with the fact that a statement assumed to be true at one time can later be found to be false. Computers, which depend on traditional logic, wherein truths are proved once and for all, can not come to grips with this — at least not yet.

Everyday abilities like talking, seeing, or sensing friendliness from a facial expression, do not normally need conscious effort. Nor can we say how we do them. As long ago as the 5th and 4th centuries BC, Socrates and Plato concluded that although early on in life we learn the rules (i.e. are programmed) for these functions, they are quickly forgotten and retained only in our subconscious mind once we grow up. None the less, these functions are far from simple. Indeed, their complexity — and subtlety — was

The Chinese Room

John Searle, Professor of Philosophy at the University of California, defines two forms of artificial intelligence research. Weak AI merely says that the principal value of the computer is that it gives us a powerful tool in the study of the mind. Advocates of Strong AI, however, maintain that the digital computer is not merely a tool, but rather, if correctly programmed, a mind that can literally be said to understand and to have other cognitive states. Searle believes that the 'equation' MIND: BRAIN + PROGRAM: HARDWARE is invalid.

Imagine yourself (it is assumed you are not a Chinese speaker) inside a closed room. Your only contact with the outside world is through a small hatch. In through the hatch comes a large batch of Chinese symbols. Some time later, another batch arrives, along with a set of rules in English (which, it is assumed, you do understand) correlating the first set with the second. You carry out the instructions, no doubt wondering what you are doing, and another batch is submitted, with more rules in English. These rules tell you to check this third set of symbols against the first two, and to send back out certain symbols from the first large batch as a result of this checking process.

After a time, you get so proficient at this process that it seems as though you are fluent in Chinese. The third lot of symbols, you see, are questions and those you send out are answers to these questions. The point here is that, although you understand the English rules, you have no idea what the Chinese symbols mean. Searle asserts that the Chinese Room is analogous to the way the digital computer works. Alan Turing showed that any computer can be reduced to a Turing machine, which merely manipulates symbols according to a set of rules. A computer running a program does precisely, and only, that. It can not, therefore, be said to understand what it is doing. In his original paper, Searle gives six replies to his argument and

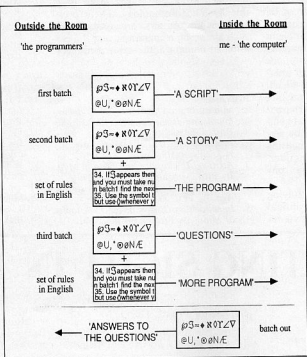

Schematic diagram of the main features of Searle's Chinese Room argument. The symbols used are, of course, not Chinese, but hopefully convey the point that taken together they mean nothing to you.

counters them. In the journal in which the paper appeared, twenty-seven further replies were given. We shall only deal here with the original six, but it may be noted that although the paper was published in 1984 the argument is still hotly debated today.

The Systems Reply. It is wrong to think of me understanding Chinese: the whole room is the understanding agent.

This seems at first glance somewhat incredible in terms of the Chinese Room, but it is motivated by the feeling that my brain understands nothing, but that I do.

Searle says that all one needs to do is "internalize" the rules, i.e., memorize them. But, one still does not understand Chinese then; merely following a set of rules one has memorized is not to understand the meaning of what they are about.

The Robot Reply. Maybe the computer on its own does not understand, but put in the cranial cavity of a robot, give the robot manipulating arms, sensors, and a television eye, and it will understand as we do.

No, says Searle, for just imagine yourself and the room inside the robot's head. I can see the symbols through the camera, I can manipulate them with my mechanical arms, but, of course, I still don't understand.

The Brain Simulator Reply. If you get the computer to actually simulate all the neuron firings at the synapses of the brain (in particular, of the brain of a native Chinese speaker), how can the computer fail to understand Chinese — it seems as if we would have to deny that the Chinese speaker understood, if we thought otherwise.

Searle thinks that the computer is simulating only part of the brain: the neural structure, but that is not enough. You could make a brain out of beer cans in a similar way and it would not think. In the context of the Chinese Room, connect the input and the output of the room via a system of water pipes and valves that are structured in the same way as the neurocortex. Yet again, I do not understand Chinese.

The Combination Reply. Combine the three previous responses so that we have a robot with a computer in its head, programmed with all the synapses, etc. of the human brain, and think of the whole thing as a unified system. We would have to ascribe intentionality* to the system.

Searle thinks it is not sufficient just to have something that looks and behaves like us.

The Other Minds' Reply. How do we know if anyone else understands Chinese? Well, by their behaviour.

According to Searle, one must presuppose the reality and knowability of the mental in the same way as we presuppose the reality and knowability of the physical world when we do physics. Obviously, this is another contentious issue in the light of some interpretations of quantum theory, for instance, but Searle gives it short shrift.

The Many Mansions Reply. Although we are working with analogue and digital computers now, in future we could well build devices that have the causal power of the brain, of which intentionality is a product.

Searle agrees wholeheartedly, but it is no argument here, because such a machine would not fall within what we now define as AI, which, in its strong form, is the only thing with which he is concerned.

* Intentionality, according to Searle, is that feature of certain mental states by which they are directed at or about objects and states of affairs in the world. Thus, beliefs, desires, and intentions (as we commonly use that word) are intentional states; undirected forms of anxiety, depressions, and so on, are not!

not appreciated until researchers tried to model them on computers.

Although the activities that involve our common sense have so far proved an insurmountable obstacle to artificial intelligence, there are as already stated expert systems that can give advice on a number of problems faced by genetic engineers, physiologists, geologists, and mathematicians. The widespread ignorance of this, perhaps not so surprising, paradox may present a danger because most people lack a reliable sense of which

questions AI systems can at present be expected to cope with.

Current development work indicates that one of the important aspects to be tackled is to give fifth generation computers a much better grasp of natural language. Most people are not prepared to learn a special programming language. Moreover, the machines would not be able to learn about their users through normal conversations. However, the difficulties are great and at present it is expected that future expert systems will

have a command of the natural language only within the subject for which it was designed.

A technology that was originally developed in the 1950s, but was abandoned after ten years, has recently been revived. It is called neural computing and could be of inestimable value in the creation of true artificial intelligence. Neural computers attempt to copy the human brain and are quite unlike conventional computers, because they are not programmed, but can learn by

example.

The brain is a complex network of interlinking neurons. It is the interlinking that is the key to solving problems quickly, but it is a problem in computer engineering: to create a 1 million-node network with 1 billion 'hardwired' interconnects would require 92 m² of silicon. The Oregon Graduate Center's Computer Science and Engineering Department is planning to build a neural computer with 10,000 nodes linked by five million interconnects. However, by using frequency-based encoding for the interconnects instead of hardwiring only 0.8 m² silicon is needed.

Neural computers may help in solving problems that still defeat conventional computers in spite of the enormous in-

crease in processing power made possible by VLSI technology. These problems include pattern processing tasks, such as speech recognition, and the creation of content addressable memories.

References:

1. Minds, brains, and programs. *Behavioural and Brain Sciences* 1980, 2. By Prof. J. Searle.
2. *Principles of Artificial Intelligence*. By N.J. Nilsson (1980).
3. *Artificial Intelligence and Natural Man*. By Prof. Margaret A. Boden (1977).
4. *Expert Systems in the Microelectronic Age*. By Prof. D. Michie (1979).
5. *Intentionality: Essays in the Philosophy of Mind*. By Prof. J. Searle (1984).

6. *Alan Turing, The Enigma of Intelligence*. By Andrew Hodges (1983).
7. *What Computers Can't Do (A Critique of Artificial Reason)*. By Prof. H.J. Dreyfuss (1972).
8. *Expert Systems Technology: A Guide*. By L. Johnson and E.T. Keravnou (1985).
9. *A Perspective on Intelligent Systems*. By L.J. Kohout (1985).
10. The Future for Artificial Intelligence. *Elektronik Electronics*, November 1985. By Prof. Margaret A. Boden.
11. How Does The Human Computer Work? By Dr. Kevan Martin. *Elektronik Electronics*, May 1987.
12. Is the Chinese Room the Real Thing? *Philosophy*, 62, 389-393. By D. Anderson (1987).
13. Minds and Brains without Programs, by J. Searle in *Mindwaves* (1987) eds C. Blakemore and S. Greenfield.

SIMULATING SIGHT IN ROBOTS

by Arthur Fryatt, CEng, MIPROdE

Although industrial robots have been in widespread use for well over ten years, their inability to respond intelligently to unexpected or rapidly changing situations has limited their usefulness to tasks in highly ordered environments. The problem is the robot's lack of awareness of what is happening around it.

Attempts to solve this problem have led to the development of sensory systems that in some measure emulate human vision, touch and hearing. Most research has concentrated on the design of computerized vision systems which act as the robot's eyes and brain to provide a basic form of artificial intelligence.

The major parameters of robot vision systems are recognition, location and inspection. With this information, a robot knows what components are present in its workspace, where they are positioned, and the extent to which they are dimensionally or structurally correct.

Although it can be seen that the development of vision systems is extending robot technology into inspection and assembly, some of the most promising commercial developments have occurred in paint spraying, welding and colour quality control of items such as fruit and vegetables. Co-operation between British research institutions, universities and manufacturers is increasing the range of commercial applications.

Practical Research

One of the leading research institutions in the United Kingdom for the development of vision systems is the National Engineering Laboratory (NEL)⁽¹⁾ which

has designed a considerable amount of software for manipulating and interpreting images. For scenes that display high contrast between components and their backgrounds, a simple thresholding operation will convert the grey scale input array into a binary image in which each pixel has the value 0 (background) or 1 (component).

Binary images can be efficiently stored in a computer memory and their simple format enables fast analysis to be carried out to determine dimensional and topological measurements. These values, along with other invariant features, can be used to build a simple component recognition and location strategy that will operate effectively on uncluttered scenes.

Reliance on high contrast effectively precludes the use of binary processing techniques in most engineering applications, which are typified by visually "noisy" conditions such as poor light levels, low contrast, or components lying jumbled together in bins partially obscured by other workpieces.

In such situations an alternative approach to recognition is based on matching local features (boundary segments, corners, holes and so on) rather than on matching global feature values (area or perimeter length, for example). The NEL has recently developed advanced techniques for the matching of local features involving the latest computer-on-a-chip device.

A practical example of robot vision work at the NEL is a recent project undertaken for the National Nuclear Corporation involving the development of a system for automatically locating fuel pins

in a nuclear fuel assembly.

Accurate information on pin position is communicated to a robot which grasps and removes each one in turn. The NEL system is ten times faster than manual dismantling.

University collaboration

A vision sensing system provides colour quality control for grading fruit and vegetables in the Autoselector, a joint development involving the Essex Electronics Centre⁽²⁾, a department of the University of Essex and Loctronic Graders⁽³⁾. Their collaboration initially led to the introduction of the Autoselector A, which employed a monochrome television imaging technique to detect differences in the grey scale.

Subsequently, with the introduction of the Autoselector C, a very significant advance has been achieved with colour imaging which enables up to 4096 colours and shades to be identified in areas as small as 3 mm diameter at very high speed.

Since the entire area of the product needs to be scanned, Loctronic Graders has developed the Thrudeck which presents constantly revolving products such as tomatoes, onions, kiwi or citrus fruits at speeds up to 2500 per minute to the camera. Even though the products are of irregular shape, the system can track, size and count each one as it follows a meandering path down the deck.

Another interesting technical achievement is the way in which the three-dimensional aspect of colour television is handled. Since a colour camera has

three channels — red, green and blue — the permutations possible could be handled only by a very large computer. In conjunction with the Electronics Systems Engineering Department of Essex University, the Electronics Centre developed a method simplifying this task so that it can be handled by hardware controlled by a Motorola 68008 micro-processor.

By selecting the region of colour hue carefully — for example green and brown for potatoes, or red and green for tomatoes — and examining tone saturation in the chosen colour sector, dimensions are reduced from three to two, which can be handled relatively easily.

Sighted robot welding

Founded at the beginning of 1984 with the help of an Oxford University research team, Meta Machines⁽⁴⁾ is now accepted throughout the world as a leading commercial organization specializing in sensors for robot control. Its MetaTorch adaptive vision guidance and control for arc welding is designed to ensure that a robotic welding system achieves consistently high quality output despite components fit-up variations and inaccuracies. The aims are minimum downtime for reprogramming in response to component batch changes, and maximum flexibility to adapt to future changes through the fixing of simple and inexpensive parts.

The company's two most recent developments are the MetaTorch 200, a compact vision sensor mounted coaxially around a MIG or TIG welding torch and the MetaTorch 500, for higher current applications, on which the vision sensor is mounted external to the welding torch. The MetaTorch system can recognize complex joint types, guiding the robot to locate, track and weld the seam in a single pass operation.

The vision processing electronics and powerful vision processor enable the system to analyse the position of the joint and communicate this information to the robot controller at a rate in excess of 10 Hz. As a result of its single pass operation and fast vision analysis, the system has no significant effect on the robot cycle time.

Used in production environments, the MetaTorch requires no optical adjustment or alignment and is quickly interchangeable. By combining a solid state laser light source and camera in a single unit, it is capable of withstanding harsh operating conditions.

Precise spraying

By combining closed circuit television with automatic paint spraying equipment, Lektrodesigns⁽⁵⁾ has developed the Videospray system, which can assess separate paint stroke requirements. It controls spray patterns individually so that irregular shapes loaded on a conveyor at random will be painted automatically with a minimum of paint. Mounted together on a single stand, the Videospray's closed circuit television (CCTV) camera with built-in monitor and electronic module are easily installed adjacent to existing spray equipment.

Any reciprocating gun can be controlled and one unit can handle up to four spray guns. To establish the relative positions of the spray gun and the item to be painted, the camera is directed so that the reflector on the spray gun, and the workpiece as it enters the spray booth, are in view. From this relationship, timing instructions are generated and stored in the logic bank to control the spray stroke, ensuring paint economy.

It is possible to achieve an accuracy of paint spray to 12.7 mm with the electronic and mechanical time lag provided

by the system, even to the extent of compensating for angular workpieces where the gun needs to be rotated through an arc. The complete Videospray installation occupies only 0.8 m² of floor space and on average rises to a height of 2 m.

The company's latest development is the Videospray II, a shape recognition system again comprising a CCTV camera linked to a microprocessor, which in turn can be connected to a painting robot to call up the appropriate part painting program. A particular feature is the method of lighting the part moving on a conveyor to give a strong silhouette for the camera to view. A microprocessor digitizes the outline shape and compares it with a pre-stored library of shapes to determine the part number. Outline recognition software routines have been incorporated to determine the attitude of parts on the conveyor, for example, higher, lower, tilted, retarded or advanced, compared with their mean positional attitude.

References:

1. National Engineering Laboratory, East Kilbride, Scotland G75 0QU.
2. Essex Electronics Centre, Wivenhoe Park, Colchester CO4 3SQ.
3. Loctronic Graders Ltd, Eves Corner, Danbury, Essex CM3 4AH.
4. Meta Machines Ltd, 9 Blacklands Way, Abingdon Industrial Park, Abingdon, Oxfordshire OX14 1DY.
5. Lektrodesigns Ltd, c/o Market Options Ltd, 75 Middle Gordon Road, Camberley, Surrey GU15 2JA.

Polarity indicator

With this device it is possible to determine the polarity of test points with respect to the circuit common.

The indicator is built around the 741 opamp. It has an input impedance of about 1 M Ω , so that there is little

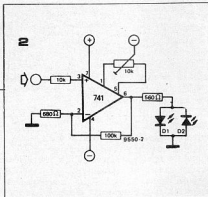
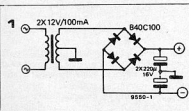

circuit loading by this device. However, when checking circuits with high impedances, the loading effects must be taken into account.

The opamp compares the voltage of the test point relative to common. If the voltage is positive so is the output of the opamp. As a result LED D1 will light. If the voltage is negative, LED D2 lights up. The pin numbers given on the drawing are related to a TO-5 case.

MAKING THE WEATHER WORK FOR YOU

The past 10 years or so have seen what are probably the greatest advances ever in weather forecasting. Certainly they are the greatest in terms of potential value of forecasts to commerce and industry.

by Dr John Houghton, Director-General and David Houghton, Marketing Director, UK Meteorological Office, Bracknell

First to appreciate how big are the benefits from better weather forecasts have been the world's airlines, traditionally the customers who work most closely with the meteorologists. This was highlighted last year when a team of scientists from the UK Meteorological Office received the prestigious Royal Society ESSO Energy Award, in recognition of their pioneering contribution to energy saving through developing the world's best operational weather forecasting model. By international agreement the world's airlines have access to flight forecasting information for all parts of the world from the Meteorological Office headquarters at Bracknell, typically information on winds and temperatures at all the heights at which aircraft fly. Airlines using Bracknell data together spend over £5000 million every year on aviation fuel, so the saving of one per cent or more in fuel consumption which can be achieved through using the better forecasts is not inconsiderable.

Forecasts contribute to fuel saving in a variety of ways. For instance, a forecast can indicate the position of the strongest tail wind so that the aircraft can be flown to take advantage of it and thereby achieve a higher speed relative to the ground, saving both time and fuel. Forecasts of temperature are also important, for air temperature influences the efficiency of the jet engines. It is possible only to conjecture on the much larger savings achieved in comparison with using no weather forecasts at all.

Global approach

Airlines are interested only in short period forecasts, for up to 24 hours ahead at the most. However, recent improvement in weather forecasting is even more evident in predictions for two, three, four and five days ahead. Until 1971 forecasts for more than two days ahead were of little practical use, certainly not in commercial terms. Then a new 10-level forecasting model was introduced, and the quality of forecasts for days two and three rose dramatically. But the model was only hemispheric: there was neither the computing capacity

nor the observing system capable of supporting a global model; indeed, it was thought at the time that over a few days the weather over one hemisphere was largely independent of the weather over the other. The latest global models of atmospheric behaviour have demonstrated that it is not so. Accurate forecasting beyond a day or two demands a totally global approach, which has been made possible through parallel advances in computing, new observing systems using both geostationary and polar orbiting satellites, and mathematical modelling of the global atmosphere. The first illustration shows how all these elements combine to provide a global forecast. The result is that today's forecasts for three to six days ahead are better by two

days than were forecasts only 10 years ago.

The acid test in any forecasting system is its ability to predict change. In the second illustration this test is applied to forecasts produced here for the area covering Europe and the North Atlantic. The element tested is surface pressure, the forecast surface pressure against the observed surface pressure. It can be seen that forecasts for day three are now as good as those for day one were 10 years ago, day four as good as day two, and so on.

Many sectors of industry and commerce can also derive considerable financial benefit from these better forecasts. But this benefit is yet to be fully realised because the forecaster is still largely

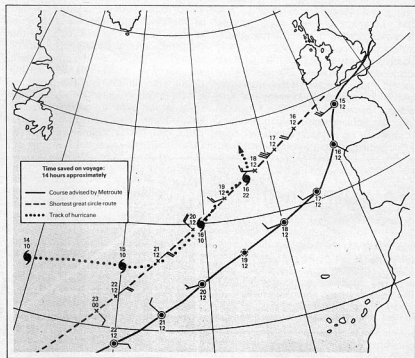

Part of a ship routing weather analysis chart issued by the UK Meteorological Office. It covers a voyage by a chemical tanker of 13 000 tonnes which left Rotterdam on 13 August 1986 bound for Trinidad. The recommended Metroute enabled the vessel to avoid the worst of the weather caused by remnants of hurricane *Claudette* and thereby save about 14 hours on passage. Figures against charted positions show the date and hour of observations, and the 'feathered' lines indicate the direction and force of the wind towards those points. Each full feather stroke indicates a wind speed of ten knots and each half stroke five knots.

unaware of the user's requirements, and the potential user is still largely unaware of what information the forecaster can provide. What is required is a marketing dialogue similar to that which has been taking place between the meteorologists and the aviators for some 70 years. The aviator has not been slow to tell the meteorologists what information he requires, and the meteorologist has responded to the best of his ability by deriving increasingly better methods of producing and communicating the required information.

Ship routing

The shipping industry are even older customers for weather information: in fact, the Meteorological Office was set up around 1855 specifically with the purpose of giving warnings of storms to ships at sea. Nevertheless, in contrast to airlines, shipping companies have been slow to appreciate the opportunities for saving time and money by using specialist routing advice. Only a small proportion of shipping uses a ship routing service, although the benefits have been shown to be great. The diagram on the front page shows the routing of a ship across the Atlantic for a minimum-time crossing. The saving achieved by avoiding adverse weather was 14 hours. Ships can also be routed on the basis of minimum wave height if, for instance, the comfort of passengers or animals is paramount.

Offshore drilling operations, especially from floating platforms, are the most weather-sensitive activities at sea. High winds and swell can be particularly dangerous for drilling and diving operations, or when platforms are being moved or towed. The cost of operating a platform is high, of the order of £1 million per week, and the value of accurate forecasts of weather and waves for a few days ahead is also high. Forecasters working on oil rigs are a vital part of the operational team.

One of the better known forecasting successes of 1986 was the record breaking achievements of the *Virgin Atlantic Challenger*. An accurate four-day weather forecast was essential, and the signal to go followed a favourable forecast from our Central Forecasting Office.

The value of a weather forecast to the aviator and the sailor is almost assumed, because they are open to the elements. The farmer is another obvious customer, though traditionally he has been regarded as so experienced a weather observer that he can rival the professional forecaster. But even for him things have changed. Now, for the first time, he is able to schedule many of his farm operations several days in advance. Armed with specialist forecasting and climatological advice, he can sow his

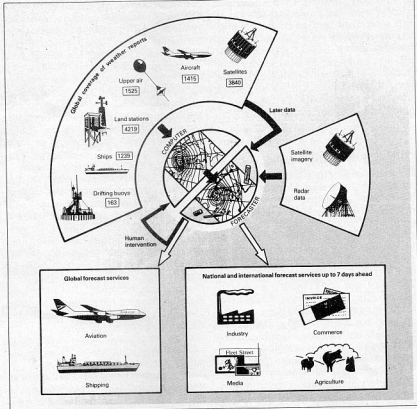

Steps from observation to forecast. Numbers indicate the average number of observations each day for use in the main 0000 utc and 1200 utc global numerical forecast model runs.

seeds, apply his fertilizers and preventive sprays, and harvest his crops, all at times to get the best yields.

Matching forecast to demand

As with other marketing business, the first aim in marketing weather forecasts is that the provider and the user be brought together in their mutual benefit. The product is weather information, both historical and forecast, specified and assembled to meet the needs of the user. Experience has shown that the majority of users of weather information cannot afford either the time or the effort to glean the information required for a particular operation by attempting to interpret a general weather summary and forecast. The full benefits which may come from weather information are reaped only when the information is tailored to the particular requirement. For example, anyone who sells umbrellas is interested only in whether it will rain at a time of day when people are likely to want to be out of doors. A manufacturer of heating equipment is vitally concerned with temperature and, because it takes several days of cold weather before demand is stimulated, he wants a package comprising both historical and forecast information. The food retailer requires a particularly complex and comprehensive package relating the expected

weather to various factors, for instance to variations in demand for a wide variety of foodstuffs, to variations in their availability if they are grown in the field, and to the ease with which they can be transported and stored. To benefit most in such cases, forecast and historical information have to be assembled so as to relate as closely as possible to the procedures for making decisions throughout the industry.

The second essential marketing consideration is how to convey weather information efficiently to the user. Should it go by digital link, facsimile or telephone; to the company headquarters, the local office or the building site? If the means of communication or the destination are wrong or inappropriate the information may be of little practical value.

Third, the price must be right. Price setting is the part of the marketing mix which many scientists will try to avoid as being at best unscientific and at worst immoral. But in this context it is not only necessary to pay for the resources devoted to the provision of the service; the price must also relate directly to the perceived value of the service. The recipient of specially tailored weather information is much more likely to use it to advantage if the cost bears some sensible relation to the benefit which may be derived. It is not that the price needs to be

high — just realistic. In practice, the price of most meteorological services is only a small percentage of the benefits derived, which makes a weather service a necessity rather than a luxury. This applies not only to individual services but on the scale of national meteorological services, too. The contribution of every such service to a nation's economy is many times the cost of the service.

Public communications

The value of weather forecasts for the public at large through newspapers, radio and television must not be overlooked. They enable people to make millions of small decisions that contribute significantly to the well-being of the community and to the efficient and effective use of its resources. For the man in the street the weather forecast may sometimes do no more than satisfy his curiosity regarding the future. On certain occasions it contributes significantly to his comfort and convenience. He can go out wearing suitable clothes and footwear, and not carrying an umbrella unless he really needs one. On at least a few days each year the forecast confers a measurable benefit. For example, he may save fuel by avoiding a leisure trip to the coast or mountains that would have been spoilt by bad weather. Just as for specialist users, the amount and quality of weather information useful to the average citizen has increased greatly in the last few years, so much so that new means have had to be

found for him to reap the benefit and for the meteorological service to reap some rewards. In Britain, a new telephone information service known as Weathercall has recently been introduced. It costs more than the average rate of charge for a call and a proportion of the charge to the subscriber is paid to the meteorological service. A similar service, Marinecall, is available to inshore sailors. It provides, detailed forecasts over 15 consecutive telephone numbers, each for a sector of the coast around Britain.

There are, of course, many other areas of industry and commerce where weather forecasts properly applied can contribute to profitability and efficiency. In the power industry weather information is essential to short and long term planning; highway authorities make huge savings during the winter by applying grit and salt only when there is advance warning that it is necessary. In building, construction, transport, manufacturing, maintenance and repair, many activities and processes are weather sensitive; and the demands for goods and services vary with the weather. The World Meteorological Organization is working to obtain better estimates of the benefits of weather services throughout the world, both to communities as a whole and to individual sectors. In the UK, a conservative estimate is that the total benefit is well over 10 times the total cost of the service.

Today, computer models give good detailed weather information up to five or six days ahead. As the models improve and as larger computers become avail-

able, the period of forecasts will perhaps be extended to 10 or even 14 days. The question then will be how predicatable is the atmospheric circulation beyond two weeks ahead? Almost certainly it cannot be forecast in detail. Nevertheless, there is a good possibility that the average character of the weather a month or two ahead may be predictable. The economic value of such predictions, even if they are not perfect, would be very large. So the stakes are high and the world is waiting on the meteorologists to tackle the problem of weather forecasting at longer range, for which they will require at the very least the next generation of supercomputers. All told, one thing is certain, the weather service is no longer seen as a luxury but a necessity.

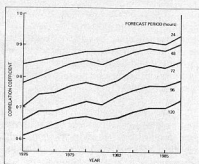

Annual average correlations between 24, 48, 72, 96 and 120 hours forecasts and actual pressure changes at sea level for the North Atlantic Region since 1976.

Liquid level indicator

This circuit was originally intended as a water level indicator for use by blind persons, to give an audible indication when a cup, bowl or other container was full. It will function with any liquid that will conduct electricity, such as beer, tap water, tea, milk. It will, of course not function with distilled or de-ionised water. The circuit has other applications

such as a rain sensor (when used with a suitable probe).

The circuit is extremely simple. The input of N1 is normally held low by a 1M resistor. When the probes are immersed in a conducting liquid the input of N1 goes high, so the output goes low and the output of N2 goes high, enabling the astable multivibrator N3/N4, which switches T1 and T2 on and off

to produce a tone from the speaker. An open collector transistor output is also provided to drive a relay or other circuit. Probe construction for level sensing and for rain sensing are shown in figure 2. The level sensor probes should preferably be made of stainless steel wire for ease of cleaning, and the circuit housing should be watertight in case of accidents.

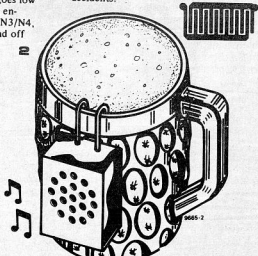
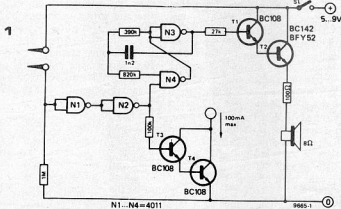



Distances can be measured in three basic ways: by using a ruler, a tape measure, or by electronic means. The first two are often time consuming and prone to inaccuracy and the third is relatively expensive. A fourth possibility is now provided by none other than this canometer, its prime merit being simplicity.

It is, in fact, just an electronic meter incorporated into an empty can and which indicates the measured distance on a digital display.

The principle behind the circuit could hardly be more basic. When a cylinder is rolled along a flat surface, the distance that it covers during one revolution will be the same as its circumference. If the diameter of the cylinder, or can,

via gate N2. However, the pulse will only be allowed through N2 when the output of the flipflop, formed by N3 and N4, is high. In other words, after the start button, S2, has been depressed. If the stop button, S3, is pressed the clock pulse will be inhibited again and any reading obtained will remain on the display. The counter section of IC2 will therefore only operate after the start key has been depressed and the can is rolling. Switch S4 serves to reset the circuit.

All the functions required to process the pulse data (counter, decoder and the multiplex control circuitry for the displays) are contained in IC2. Common cathode displays are used and the decimal point of Dp2 is utilised to distinguish between metres and centimetres.

Although IC2 requires a regulated supply voltage of 5 V, it appears to work quite happily at lower voltages as well. A supply voltage slightly greater than 4 V was therefore selected so that three 1.5 V batteries (connected in series) can be used for the power source. A 9 V battery could also be used if the canometer is not going to be rolled very often. To keep dissipation down to a minimum a germanium transistor (T1) has been incorporated to stabilise the supply voltage. The circuit has only one adjustment point, potentiometer P1. This regulates the sensitivity of the photo transistor.

canometer

measuring can

S. Heilmann

The fact that a can has insulative properties was the inspiration behind this particular design in which the roll plays a very important role. The circumference of the can is used to measure distances with a fair degree of accuracy. The distance covered, or rather, rolled is indicated on a four digit display, the maximum readout being 99.99 metres.

is known, along with the number of revolutions the can has made, the distance covered can be calculated very easily. Therefore, the electronics involved only has to record the number of revolutions, calculate the distance travelled and display the result. However, with a little bit of ingenuity, we can dispense with the mathematical section altogether, thereby making the electronics even simpler.

The diameter of the common 0.33 litre can is approximately 65.8 mm. This can be increased to 66.8 mm by adding a layer of sellotape around the can. This will then bring the circumference of the can up to 21 cm, a nice whole number.

To detect how far it has travelled, the can utilises a disc which has 21 segments. Each segment consists of a dark and a transparent section. The disc can revolve on a central axis and is weighted with either lead or solder so that the weighted portion will remain face downwards when the can is rolling. A photo detector construction from an LED and a photo transistor, on either side of the disc, is incorporated so that the transistor generates a pulse each time a segment rolls past. Since there are 21 segments and the can has a circumference of 21 cm, you don't need a degree in mathematics to work out that each pulse from the photo transistor corresponds to 1 cm of travel!

Effectively, the can rolls together with all its contents (circuit boards, battery etc.) but the disc stays still.

Circuit diagram

The circuit diagram of the canometer is shown in figure 1. The photo detector mentioned previously is made up from LED D2 and the photo transistor T2. Whenever the light from the LED passes through transparent section of the disc transistor T2 will generate a pulse. This pulse is shaped by the schmitt trigger N1 and fed to the clock input of IC2

Construction

The complete circuit can be mounted on two printed circuit boards as shown in figures 2 and 3. The round display board is mounted at right angles to the rectangular board after which the corresponding connections are made with short wire links.

The axle for the segmented disc is mounted on the rectangular board in the position marked by a dotted line. The space with the triangular points next to it has to be removed first with the aid of a fretsaw. This is essential so that the disc will be positioned correctly between the LED and the photo transistor.

The segmented disc is illustrated in figure 5. In fact this can be carefully cut out and glued onto a circular piece of perspex with the same diameter. This is then weighted with lead or solder, bearing in mind that the completed disc must be able to pass through the slot in the board without touching the sides. Once it is mounted on the axle it must be able to turn freely.

Prior to final assembly in the can, preset potentiometer P1 should be adjusted so that the display increments by one each time a segment of the disc passes through the light beam (after S2 has been depressed of course!).

The only other requirements are that the can needs to be 'screened' so that no light can enter to cause a misreading and

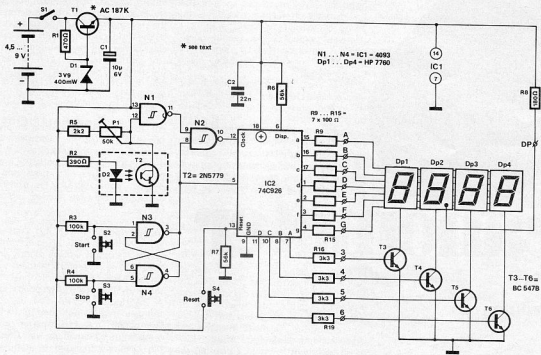

Figure 1. The complete circuit diagram of the rolling distance meter.

ATTENTION

**PCBs
& Set of COMPONENTS**

for projects are normally available with

precious®
ELECTRONICS CORPORATION

52-C Proctor Road, Bombay-400 007 Phones: 367459/369478

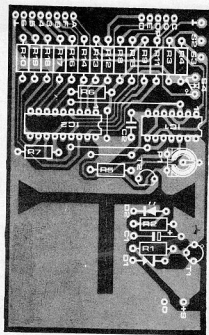

Figure 2. The printed circuit board and component layout for the main part of the circuit. Provision has been made for mounting the segmented disc on this board.

ATTENTION

**PCBs
& Set of COMPONENTS**

for projects are normally available with

precious[©] ELECTRONICS CORPORATION

52-C Proctor Road, Bombay-400 007 Phones: 367459/369478

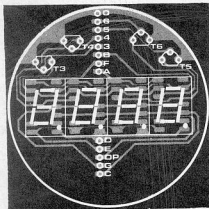

Figure 3. The printed circuit board and component layout for the display section.

4

parts list

Resistors:

R1 = 470 Ω
 R2 = 390 Ω
 R3, R4 = 100 k
 R5 = 2k2
 R6, R7 = 56 k
 R8 = 180 Ω
 R9 ... R15 = 100 Ω
 R16 ... R19 = 3k3
 P1 = 50 k preset potentiometer

Capacitors:

C1 = 10 μ /6 V
 C2 = 22 n

Semiconductors:

T1 = AC 187K
 T2 = 2N5779 or equivalent
 T3 ... T6 = BC 547B, BC 107
 D1 = zener diode 3V9, 400 mW
 D2 = LED red
 IC1 = 4093
 IC2 = 74C926, 74C928
 Dp1 ... Dp4 = HP 7760

Miscellaneous:

S1 = single pole switch
 S2, S3, S4 = push button.

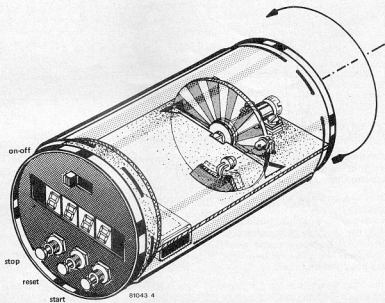

Figure 4. The construction of the canometer and the suggested format of the disc. The latter can be cut out and pasted onto a perspex disc of the same diameter.

5

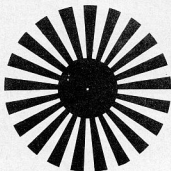

Figure 5. The segmented disc can be cut out and glued onto a circular piece of perspex.

the axle for the segmented disc must be positioned in line with the central axis of the can.

Operation

The directions for use as given by the author are so clear there is no need to add anything to them:

- * Switch on the canometer
- * Place the can at the starting point of the distance to be measured, press 'reset' followed by 'start'
- * Roll the can as evenly as possible until the 'finish', then press 'stop', pick up the can and read off the dis-

- distance measured from the display
- * Note that the unit will only work correctly when the can is rolled in one direction. If the canometer is put into reverse half way through a measurement an incorrect reading will result.
- * Interim measurements are also possible: 'stop' is pressed at the required point, the distance indicated on the display is noted and the can is replaced in the same position. Then press the 'start' button and continue.
- * Do not forget to switch off the canometer after use.
- * Roll on!

SWITCHING TRANSISTOR

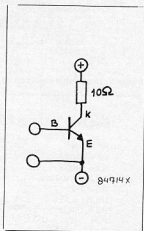
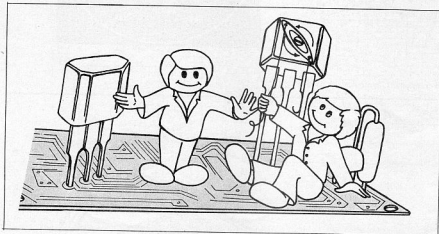

"... what is a switching transistor?"

"A switching transistor is a transistor used for switching!"

"You mean a transistor can operate a switch? Like we do?"

"No, that would be difficult for a transistor, but the transistor itself acts as a switch."

"Oh, I see, and how are the contacts made in the transistor?"

"No, there are no mechanical contacts and springs etc. inside the switching transistor. It looks like a normal transistor, however, it does not amplify a signal uniformly like a normal transistor. It either conducts or does not conduct at all."

"Like a tap which is either fully open or fully closed?"

"Correct, and that is why it is called a switching transistor. It is either fully open for the current or fully closed."

"Which terminals are the switch contacts?"

"Obviously the collector and the emitter, because the main current of a transistor flows between collector and emitter."

"And the base?"

"Base is the control terminal. When base current flows, the switch is on"

"But the collector-emitter junction can conduct only in one direction!"

"That is right."

"So the switching transistor is not really a switch?"

"Yes and no! It is a switch, but it is a switch with a diode in series! Also it has another small disadvantage that the voltage between collector and emitter never really goes to zero."

"That means a switching transistor can never replace a real switch."

"Yes, but this remaining voltage across the junction is just 0.1 and 0.2 V, and can be neglected in most cases. This voltage is known as the saturation voltage."

"Saturation voltage? With what is this transistor saturated?" "When the base current becomes so high that any further rise in it cannot make a proportionally higher current to flow through the collector, the transistor is said to be saturated."

"I don't quite understand."

"Take an example. A switching transistor is to switch a voltage of 10V through a 10 Ω resistance. When there is no base current, there is no collector current and the transistor switch is off. Now when base current flows, the transistor is switched on and current flows through the resistor. How much current will flow?"

"10 V across 10 Ω, that gives 1 Ampere."

"Yes, if you neglect the 0.1 V saturation voltage. For a 1 A collector current, now you can calculate how much base current will be required?"

"For that you must tell me the current amplification of the transistor."

"Yes, you are right, say it would be 100....."

"then you have 10 mA base current flowing."

"And what do you think will happen if I force a current of 20 mA into the base?"

"Well, then that extra 10 mA has to come out from somewhere!"

"Exactly, and this is what is known as saturation. This extra base current is no longer amplified but it just comes out at the emitter. This happens because 10 V across 10 Ω cannot allow more than 1 A current through collector."

THE TRANSISTOR —

An Electronic Potentiometer

A transistor is often compared to a potentiometer, to explain how it works. Though the analogy is not correct in all respects, it certainly helps in a better understanding of the functioning of a transistor.

Figure 1 shows the symbol of the transistor and the direction of current flow. The base current flows from base to emitter and the collector current flows from the collector to emitter. The analogy of a potentiometer is shown in figure 2, where the transistor is shown as a current controlled

potentiometer. The sliding contact rises up towards the collector, as the base current goes on increasing. This can be imagined to happen in such a manner that the collector current is higher than the base current by a factor of B which is the current amplification factor of the transistor. This is just a theoretically simplified picture. It just helps to illustrate the fact that by increasing the base current, the collector current can be increased to a much larger extent, which is called amplification.

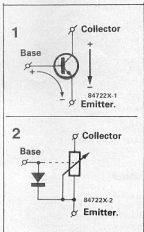
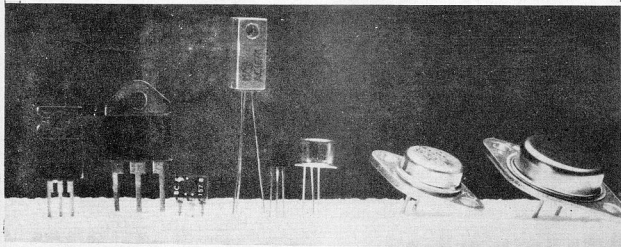
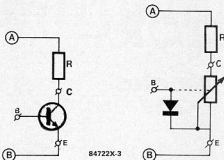

Figure 1: Two important current paths of an NPN transistor. The base current controls the emitter current. The ratio of Collector Current to base current is called the current amplification factor B.

Figure 2: The potentiometer model of the transistor. Easy to understand but theoretically inaccurate.



3



84722X-3

4

Output characteristics I_C/U_{CE} for different values of I_B
BC 107, BC 108, BC 109

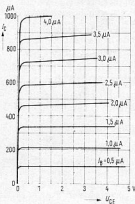

84722X-4

Figure 3: With a resistance in the collector circuit, the potentiometer model of the transistor does not hold any longer.

Figure 4: The output characteristic curves of an NPN transistor BC 108. The curves clearly show that the collector current depends only on base current and not on collector voltage.

Figure 5: Even though the collector current depends only on base current, it is possible to control the collector voltage by collector current. This can be done by introducing a resistance in the collector circuit.

5

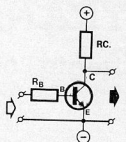

84722X-5

This comparison does not hold in real life. If we add a resistor in the collector side of the transistor, as shown in figure 3, the inaccuracy of the potentiometer model becomes visible. In the real transistor, certain collector current flows for a certain base current independent of the collector voltage, whereas in the potentiometer model, the collector current also depends on the collector voltage and a voltage divider action takes place due to the resistance R in the collector circuit. This point will become clear from figure 4, which shows the output characteristics of an NPN transistor BC 108.

Several curves are plotted, for different base currents, showing the relation between I_C (Collector Current) and U_{CE} (Collector Voltage). The higher the base current, the higher lies the characteristic curve. From this figure it can be seen that after the collector

voltage U_{CE} crosses a certain minimum level, I_C becomes almost constant, independent of U_{CE} .

If we see the circuit of figure 3 now in this light again, we can see that the collector current for a given base current can influence the collector voltage only through R and the voltage across points A & B. The collector current would remain constant. However, in the potentiometer model, the collector current is influenced by the value of R as well as the voltage across A and B.

From figure 4, it becomes very clear, that the collector voltage is not controlled either by base current or the collector current. It can be controlled only by adding a resistance in the collector circuit as shown in figure 5. The circuit shown here is the Common Emitter circuit. When the base current flows from base to emitter, a fixed amount of collector current flows through the collector circuit. As we have a resistance R_C in the collector circuit, there is a voltage drop across R_C which is equal to $I_C \times R_C$. If we have a constant supply voltage, the collector voltage will naturally be less than the supply voltage by an amount $I_C \times R_C$. In this way, it is also possible to control the collector voltage. As the base current rises, collector voltage drops, depending on the value of R_C . The transistor, which is basically a current amplifier, can also be used as a voltage amplifier in this way.

The Digilex-PCB is available!

Price:
Rs. 85.00 + Maharashtra Sales Tax.
Delivery charges extra: Rs. 6.00

Send full amount by DD/MO/PO.

Available from:

precious[©]

ELECTRONICS CORPORATION

Journal Division

52-C, Practor Road,
Bombay-400 007
Ph. 367459, 369478
Telex - (011) 76661 ELEK IN

NEW PRODUCTS • NEW PRODUCTS • N

Weighing Balances

The Bombay Company Limited in collaboration with A & D Company Limited of Japan have started manufacturing, a range of nine models of High Precision Electronic Weighing Balances. These balances are sold under the brand name of AFCOSET.

The accuracies of the various models range from 0.00001 gm for weighings upto 32 gm to 0.1 gm for weighings upto 20 Kg. The AfcoSet Balances can be used as stand alone Balances for determination of weight or with the use of the optional RS-232C interface can be connected to a printer or computer for on-line analytical work.

AfcoSet balances can be used for various applications like quality control to inventory control, stores and shop-floor weighing.

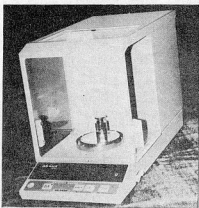

The Bombay Company Limited • 334, A-Z Industrial Estate • G Kadam Marg • Lower Parel • Bombay-400 013.

STRIP CHART RECORDER

With 32 channels every two seconds scan frequency, MOLYTEK'S 2702 is a fast multipoint strip chart recorder. The state of the art microprocessor technology has been used to pack a host of useful features into its compact size. The auto calibrating and auto scaling 2702 can accept any combination of thermocouple, RTD, voltage and current inputs. Specific type of inputs can be assigned to individual channels thru the keyboard. The thermal paper printing coupled with dot filling features provides sharp printing. Various parameters like chart speed, margins, channel information, alarm setpoints, relay logic, math functions etc. are all field programmable thru a typewriter like slide-in keyboard.

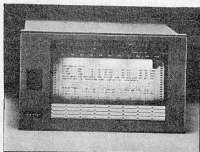

These parameters are retained in battery backed-up memory during the power down conditions. A battery backed up real time time clock keeps precise time and date for accurate records. 2702 comes with a standard RS-232 computer interface. Software is available to network upto 16 of 2702 units with one IBM-PC/XT giving a full fledged distributed data acquisition system.

JELTRON INSTRUMENTS (I) PVT., LTD.,

• 6-3-190/2, Road No. 1, • Banjara Hills
• Hyderabad 500 034. • Tel: 222411

Power Supply

Puneet Model DC-22 is an accurate and stable DC Power source with output varying from 0 to 30 V and current from 0 upto 20 Amps. It incorporates continuous current and voltage limiting. It has short circuit protection. This is a dual output supply which can be used in independent mode or tracking mode. Regulated power supplies with specific output voltage and current values are also made against specific enquiries.

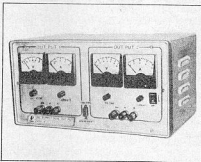

M/S. PUNEET INDUSTRIES,
• H-230, Ansa Industrial Estate,
• Saki-Vihar Road, • BOMBAY 400
072.

Milliohm Meter

Economy offers a digital Milliohm meter with a 3½ digit, 7 segment RED LED display, 5 ranges with lowest range of 200 milli ohm with 0:1 milli ohm resolution and highest range of 2 K ohm with 1 ohm resolution. Other ranges are 2 ohm, 20 ohm, 200 ohm. Selection is by interlocked push button switches. 4 wire measurement avoids lead resistance error. Accuracy of $\pm .05\%$ of range $\pm 0.1\%$ of reading ± 1 digit is reported.

Cabinet size: 247 mm Depth x 195 mm Width x 92mm Height. Weight: 2.5 kg.

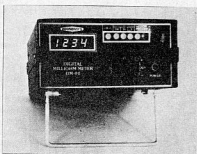

M/s. ECONOMY ELECTRONICS,
• 15, Sweet Home, Plot No. 442, • 2nd
floor, Pitamber lane, • Off. Tulsii pipe
road, Mahim, • Bombay 400 016.

Earth Sleeving

Suresh Electric & Electronics has developed Earth Sleeving, for use in electrical and electronic industries. The sleeves are manufactured in yellow colour with green stripe, and comply with international regulations for marking of single core cables and conductors. They are manufactured from plasticised PVC resistant to oils, ageing, light, ozone, acids and alkalies and can withstand temperature from -35°C to $+95^{\circ}\text{C}$.

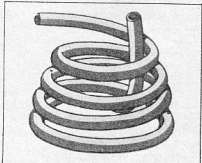

SURESH ELECTRICS & ELECTRONICS,
• Post Box No. 9141, • Calcutta
700 016. • Phone: 29 0482, 29 5939.

RES & TRANS

RES & TRANS

RES & TRANS

If your child
is a **CHIP** of
the **OLD BLOCK**,

He deserves

RES & TRANS

The Electronic Comic-Books
in **Electro Technology**

From the publishers of **elektor**

10% Discount

Special 10% Discount
on payment received
before 30th July

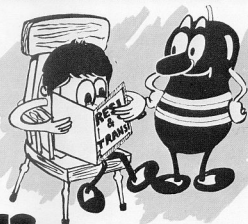
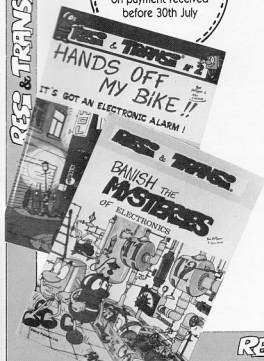

RESI & TRANS I

BANISH THE MYSTERIES OF ELECTRONICS!

In the course of the book, they explain how to build a few practical circuits, a continuity tester, a Morse code, beeps & an amplifier.

A Printed Circuit Board is included to simplify the actual construction as well as an extremely useful gadget, The Resimeter

RESI & TRANS II

Hands of my Bike!!

Electronics & Cartoons?

Why not? In this, their Second Book Resi & Transi set about building an Electronics Alarm with a powerful siren to protect a bike, motorbike, car or even a house. And, as usual they are totally indifferent to the normal code of practice of electronic components. But then, who ever said the electronics has to be dull? Resi & Transi make **ELECTRONICS** easy ... and fun.

Price: Part 1 - Rs. 90/- , Part 2 - Rs. 75/-
Packing and postage free.

Send full payment by M.O./I.P.O./D.D. No
Cheque Please. to:

precious[®]
ELECTRONICS CORPORATION

52-C, Proctor Road, Bombay-400 007
Ph. 367459, 369478 Telex-(011) 76661
ELEK IN

RES & TRANS

RES & TRANS

Your Right Connection...

Champion

The Champion Connectors!

- o Dual In-line IC Sockets.
- o Single In-line IC Sockets.
- o Pin Grid Array Sockets.
- o Socket Adaptors.
- o Cage Jacks.

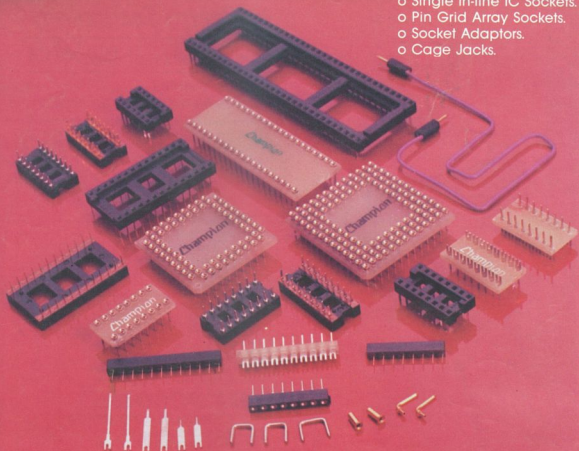

Champion Electronics Pvt. Ltd.

S-17, M.I.D.C. Bhosari, Pune 411 026, India. (0212) 82682, 83791 Cable - CHAMPION
Telex: 0146-343 CHMP IN. 0145-333 MCCI IN. 0145-505 MCCI IN.